

## Appendix J

---

**NOTE: Appendix Information is for Reference Only. Contact Local Entity Engineer for Current Information.**

Appendix J shall be used for Bus Stop Design Standards and Guidelines within the City Limits of Fort Collins.

Appendix I shall be used as a reference for Bus Stop Design Standards and Guidelines within Larimer County GMAs.

# TRANSFURT

## BUS STOP DESIGN STANDARDS & GUIDELINES

July 21, 2015



# ACKNOWLEDGEMENTS:

---

## **Technical Advisory Committee**

Noah Al Hadidi, CSU Student

Sarah Allmon, Barrier Busters Public Transportation Advisory Group (PTAG)

Vivian Armendariz, Citizen

Michael Devereaux, PTAG, Commission on Disability

Kathryn Grimes, Bike Advisory Commission

Jamie Rideoutt, Lamar Advertising Company

Ed Roberts, Transportation Board (past member)

Carol Thomas, Transfort Safety, Security and Training Manager

## **Project Management Team**

Emma Belmont, Transfort – Transit Planner

Steve Gilchrist, Traffic – Traffic Engineer

Aaron Iverson, FC Moves – Senior Transportation Planner

Tim Kemp, Engineering – Civil Engineer III

Tom Knostman, Streets – Pavement Engineer

Kathleen Walker, Transfort – Operations Manager

## **Graphics and Formatting**

Slate Communications

BHA Design Incorporated

# CONTENTS

---

## 1. OVERVIEW

- 1.1 PURPOSE
- 1.2 THE DEVELOPMENT OF THESE STANDARDS AND GUIDANCE
- 1.3 INTEGRATION WITH OTHER STANDARDS GUIDANCE

## 2. THE BIG PICTURE

- 2.1 INTRODUCTION
- 2.2 TRANSIT SYSTEM OVERVIEW
- 2.3 BUS STOP INSTALLATION AND UPGRADE — HOW DOES IT HAPPEN?
- 2.4 OBSTACLES TO IMPROVING TRANSIT INFRASTRUCTURE
- 2.5 BUS STOP MAINTENANCE AND ADVERTISING

## 3. STREET-SIDE CHARACTERISTICS

- 3.1 INTRODUCTION
- 3.2 STOP SPACING
- 3.3 STOP LOCATING
- 3.4 IN-STREET DESIGN
- 3.5 TECHNICAL DETAILS

## 4. CURB-SIDE CHARACTERISTICS

- 4.1 INTRODUCTION
- 4.2 UNIVERSAL DESIGN AND ADA ACCESSIBILITY
- 4.3 BUS STOP TYPES
- 4.4 AMENITIES
- 4.5 BUS STOP TYPE DETERMINATION

## 5. NEXT STEPS

- 5.1 INTRODUCTION
- 5.2 TRANSFERT BUS STOP IMPROVEMENT PLAN
- 5.3 RECOMMENDED FUTURE ACTIONS

## 6. APPENDIX

- 6.1 BUS STOP DEVELOPMENT FORM
- 6.2 LAND USE CODE SECTION 3.6.5
- 6.3 TECHNICAL DESIGNS (As Incorporated into Larimer County Urban Area Street Standards)
- 6.4 CITIZEN ADVISORY COMMITTEE LETTER OF SUPPORT

# 1. OVERVIEW

---

## 1.1 PURPOSE

The purpose of the Bus Stop Design Standards and Guidelines document is to assist City staff, developers, local partners and private property owners in locating and designing bus stops and their associated passenger amenities within the City of Fort Collins as well as the greater Transfort service area. The document consists of five chapters:

- **Overview** – discusses how to use the standards and guidance
- **The Big Picture** – discusses the transit network as it currently exists and the envisioned future of transit service in Fort Collins
- **Street-side Characteristics** – discusses the factors associated with the roadway that influence bus operations
- **Curb-side Characteristics** – discusses the factors associated with the comfort, safety and convenience of patrons at bus stops
- **Next Steps** – discusses Transfort’s approach to pursue capital improvements and outlines related action items related to bus stop accessibility

## 1.2 THE DEVELOPMENT OF THESE STANDARDS AND GUIDANCE

This guidance document was created with the assistance of a Citizen Advisory Committee (CAC), created by Transfort, comprised of local transit riders, cycling advocates, safety specialists, urban designers, students, media professionals, Transfort staff and other interested parties. The CAC members included individuals with a wide range of abilities and experiences with the transit network.

A project management team (PMT) of City staff also assisted in the development of this document. This group focused on the technical components and safety considerations as they relate to bus stops. The following City departments were represented in the PMT: Engineering, FC Moves, Planning, Streets, Traffic, and Transfort.

In addition, Transit Cooperative Research Program (TCRP) Report 19 – Guidelines for the Location and Design of Bus Stops, as well as various other transit agency bus stop design documents, provided best practices and general guidance in the development of the standards and guidance outlined in this document.

## 1.3 INTEGRATION WITH OTHER STANDARDS AND GUIDANCE

There are various tools that work in tandem with this standards and guidance document. Within the Transfort department, other important guidance tools that may provide guidance on facilities and services include: Transfort Strategic Operating Plan (TSOP), Transfort Operating Manual (TOM), and Transfort Service Standards. Additional documents that govern site development include: Fort Collins Land Use Code (LUC) and Larimer County Urban Area Street Standards (LCUASS). If conflicts arise between these documents, the more specific and/or stringent standard will apply.

# 2. THE BIG PICTURE

---

## 2.1 INTRODUCTION

Bus stops are a critical part of the transit system as they serve as the first point of contact between the customer and the service. In addition, bus stop placement throughout the community acts to promote alternative modes of transportation to the traveling public. The spacing, location and design all affect the operation of the transit system and, in turn, the transit patron's satisfaction. The standards and guidance in this document are intended to guide the design of transit stops that complement their immediate surroundings, meet the transit patron's comfort and safety needs, and support an efficient transit network.

The placement of transit stops is guided by safety considerations, community context, patron's origins and destinations, opportunity, and Transfort's strategic planning efforts. The TSOP is Transfort's long range planning tool; however, it is possible that community growth and change will occur in ways not anticipated by the TSOP, and therefore routes and bus stops may be different from those envisioned in the TSOP. The TSOP proposed long range routes are depicted in Figure 2 below.

## 2.2 TRANSIT SYSTEM OVERVIEW

The City of Fort Collins operates its own transit system, which is branded as Transfort. Transfort operates fixed route transportation within the City of Fort Collins and in parts of unincorporated Larimer County. Complementary paratransit service is contracted to and operated by Veolia Transportation. A regional express route, known as FLEX, is provided through a partnership between Fort Collins, Loveland, Berthoud, Longmont and Boulder County. Transfort bus stops are located within Fort Collins city limits as well as in unincorporated Larimer County, the City of Loveland, the Town of Berthoud, Boulder County and the City of Longmont.

Transfort's route map (August 2015) is provided below in Figure 1. Following Figure 1 is a map of the long range vision for transit service in and surrounding Fort Collins, Figure 2. This map illustrates the TSOP vision for a full transition into a productivity-based grid system. It incorporates the Phase 3 planned routes, along with additional recommendations from other adopted plans



and new routes that have been added since the TSOP's adoption. The purpose of this map is to indicate where new bus stops will be located as development occurs throughout the city.

**Figure 1 — Transfort All Routes Map (Effective August 2015)**

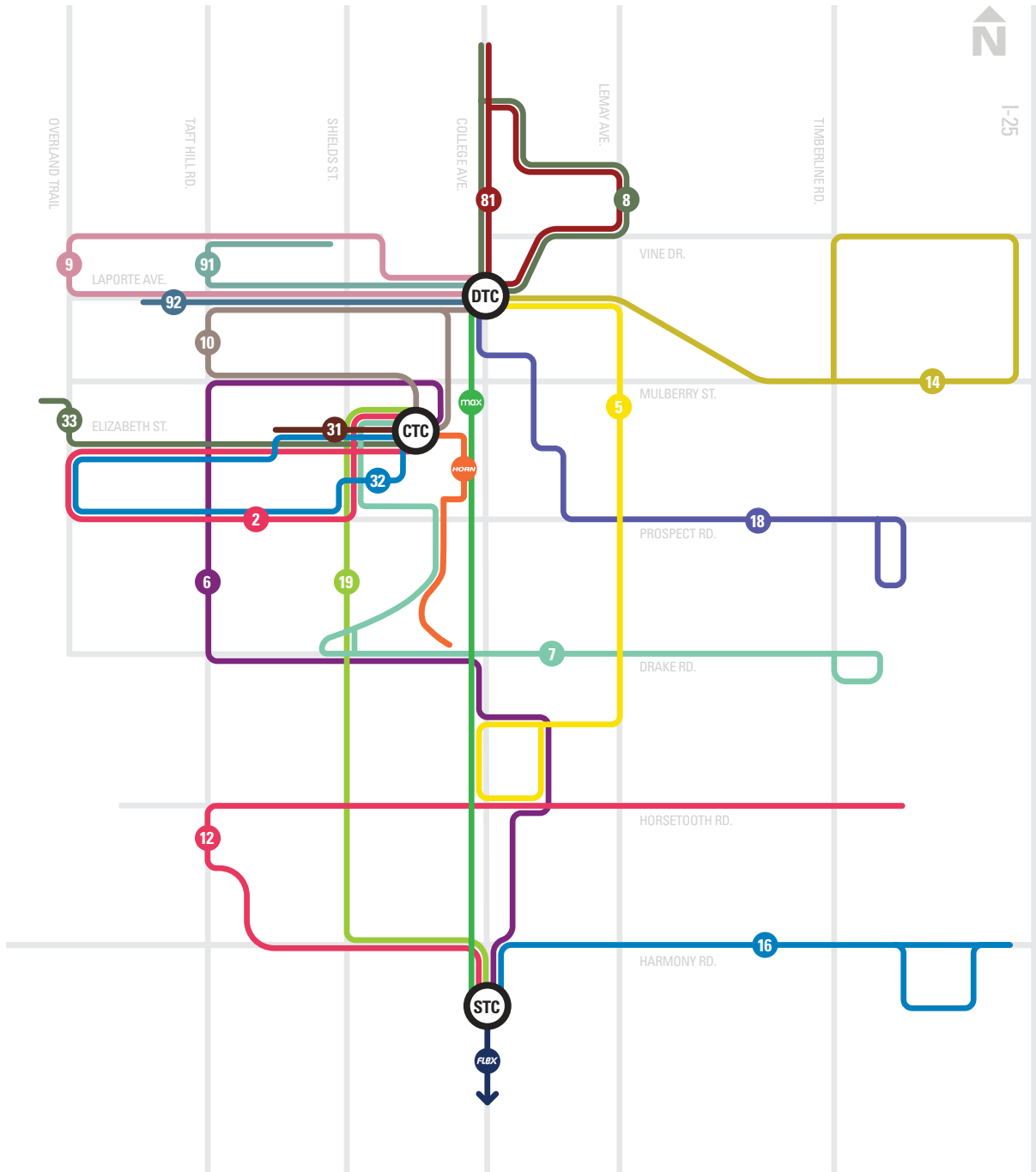
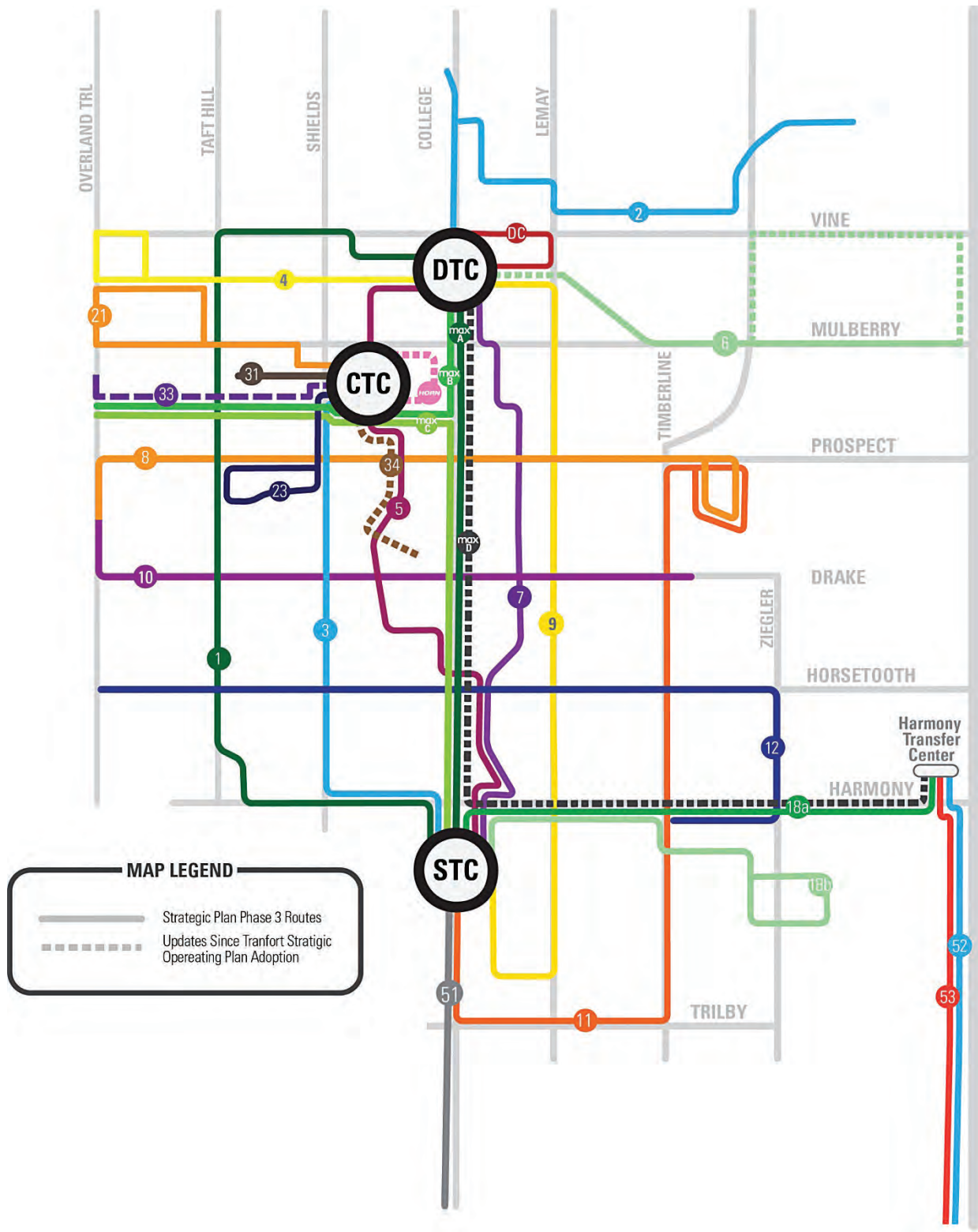




Figure 2 – Tranfort Strategic Operating Plan Phase 3 Routes and Proposed Changes



## 2.3 BUS STOP INSTALLATION AND UPGRADE — HOW DOES IT HAPPEN?

There are just over 500 existing bus stops in the Transfort system; of these, some meet the standards outlined in this document and some do not. In addition to existing bus stops that Transfort currently serves, the TSOP sets forth a plan for expanded service which will require new transit facilities throughout Transfort’s service area.

There are a variety of ways transit facilities are installed and upgraded throughout the Transfort system, and they are described below:

- **Transfort’s Capital Improvement Plan** — The Improvement Plan, which is based on location specific criteria, identified in the Bus Stop Development Form (Appendix 1) and Section 4.5, prioritizes bus stop improvements in the Transfort Service Area. Transfort anticipates an annual budget of \$100,000, based on dedicated tax revenue (Building on Basics), for bus stop improvements. It is estimated that this amount will fund approximately 7–10 bus stops annually. Transfort also pursues grants to fund additional improvements. Improvements are generally implemented according to the Improvement Plan, but obstacles do arise as described in Section 2.4.
- **Transfort’s Service Agreement for Bus Stops** — Transfort contracts with an advertising company for the installation, provision of passenger amenities and maintenance of Transfort’s bus stops. This agreement permits Transfort to request solid surface upgrades to bus stops that are located within public right-of-way (ROW) and installation of passenger amenities at bus stops in Transfort’s service area. In a typical year, this agreement provides for the upgrade of approximately 10 bus stops.
- **Development and/or Redevelopment** — As properties develop and redevelop within city limits the City’s Land Use Code (LUC) requires that the development accommodate both the existing and planned transit network (LUC Section 3.6.5 text included in Appendix 2). This requires developers to provide the necessary transit infrastructure and passenger amenities, if applicable, on or adjacent to their property. Developer responsibilities may include: dedicating additional public ROW; dedicating a Transit Easement; installation of a bus stop solid surface; installation of a bus pullout; and installation of or payment in lieu for

the applicable bus stop passenger amenities, all in accordance with the standards set forth in this document.

- ▶ Transfort does not have control over which stops are improved via this method. Bus stop improvements may not be in accordance with the Improvement Plan Priorities set forth in this document.
- **City Capital Improvement and Street Maintenance Projects** — Every year the City's Engineering and Streets Departments implement capital improvements and street maintenance. These departments manage infrastructure improvements and work with Transfort to help upgrade bus stops, as needed in the area of the project's impact. Since stops improved through this method are opportunistic, improvements may not reflect the same priorities as listed in the Improvement Plan.

## 2.4 OBSTACLES TO IMPROVING TRANSIT INFRASTRUCTURE

Many obstacles exist outside of Transfort’s control, which makes providing quality transit facilities challenging at times. Obstacles to improving bus stops include: available space (including public ROW) for stop infrastructure (solid surface and passenger amenities); accessible neighborhood sidewalks connecting to stops; accessible street crossings; and temporary obstacles such as those due to weather events like snow, rain or hail. Transfort actively works with other City departments to make improvements to the sidewalk network and to add accessible bus stops in conjunction with City construction activities. However, it will take many years for all stops to be improved because infrastructure deficiencies are widespread. Images 1, 2 and 3 below demonstrate some of the obstacles that limit transit facility improvements.

**Image 1**



**Laporte and Overland Eastbound (EB)**

- Obstacles:
- Limited public ROW
  - No sidewalks

**Image 2**



**Shields and Swallow Northbound (NB)**

- Obstacles:
- Limited public ROW

**Image 3**



**Harmony and Corbett (EB)**

- Obstacles:
- Covered section of ditch runs between sidewalk and edge of street

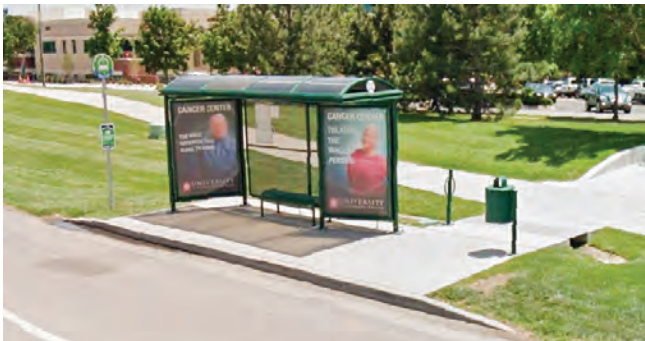


## 2.5 BUS STOP MAINTENANCE AND ADVERTISING

Transfort, like many transit agencies across the nation, utilizes advertising revenue to provide both maintenance of and passenger amenities at bus stops. Transfort contracts this service with an advertising contractor, allowing them to advertise at Transfort bus stops. In return, Transfort benefits from a portion of the advertising revenue, as well as the contractor’s maintenance of bus stops (including snow removal) and the contractor’s provision of passenger amenities and solid surface installation at locations within public ROW. However, advertising is not permitted at all bus stops within Transfort’s network. In single family residential areas, for example, advertising is limited to side-yards. In addition, certain areas may not be appropriate for advertising, such as historically significant sites. In such cases, Transfort has a limited number of non-advertising bus stop benches and shelters that can be used if advertising is deemed to be incompatible with the character of the area.

Images 4–7 below are examples of advertising at Transfort bus stops.

**Image 4**



**Harmony and Timberline (EB)**

**Image 5**



**Harmony and Larkbunting (WB)**

**Image 6**



**Rock Creek at Fossil Ridge High School (EB)**

**Image 7**



**Taft Hill and Drake (NB)**

# 3. STREET-SIDE CHARACTERISTICS

## 3.1 INTRODUCTION

This section discusses preferred and alternative street-side or in-street stop designs. Street-side characteristics refer to features associated with the roadway that influence transit operations. These features include elements such as: traffic speeds, street design, intersection design and the location of acceleration/deceleration lanes. Street-side features influence the location of and in-street design of bus stops. It is important to note that since stop designs were developed based on standard roadway characteristics, the on-site context may call for locations or designs that are tailored to that context. Ultimately, Transfort staff, with the input from the City's Traffic, Engineering and FC Moves Departments, will make the final decision on the location and design that is appropriate for a given situation.

Image 8

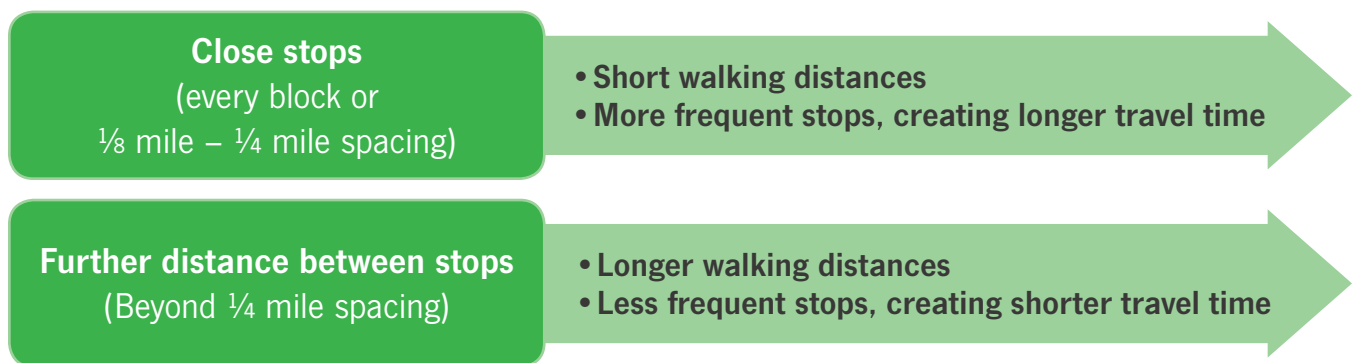




## 3.2 STOP SPACING

Stop spacing refers to the distance between stops along a bus route. Stop spacing takes into consideration the trade-offs between vehicle travel times and walking distances to bus stops. While more frequently placed bus stops reduce walking distances, it also slows down bus service. In contrast, longer distances between stops increases vehicle speed but may result in customers having to walk longer distances to get to bus stops. This is described in TCRP's Report 19 as trade-offs between operating efficiencies and customer accessibility, as follows:

**Table 1 – Trade-offs of Stop Spacing**



TCRP Report 19 also describes the industry standards for bus stop spacing typically being subdivided by land use types/densities or locating stops near major trip generators. This suggests using closer spaced stops in more densely populated areas, such as the central business core, and increasing space between stops when approaching more suburban and rural areas of the community. In addition Bus Rapid Transit (BRT) type routes generally suggest an increased distance between stops to decrease travel times. Table 2 below describes typical ranges for the different land use environments.

Transfort uses these ranges as references, but in general the main considerations for bus stop locating and spacing are safety, such as reducing bus and vehicle conflicts, and major trip generators, such as, community activity centers and concentrations of residences and businesses. Where feasible, stops shall be located approximately  $\frac{1}{4}$  mile apart. In locations where stop spacing is more than  $\frac{1}{3}$  mile apart, a midpoint stop may be considered if adjacent land uses warrant such additional stop placement.



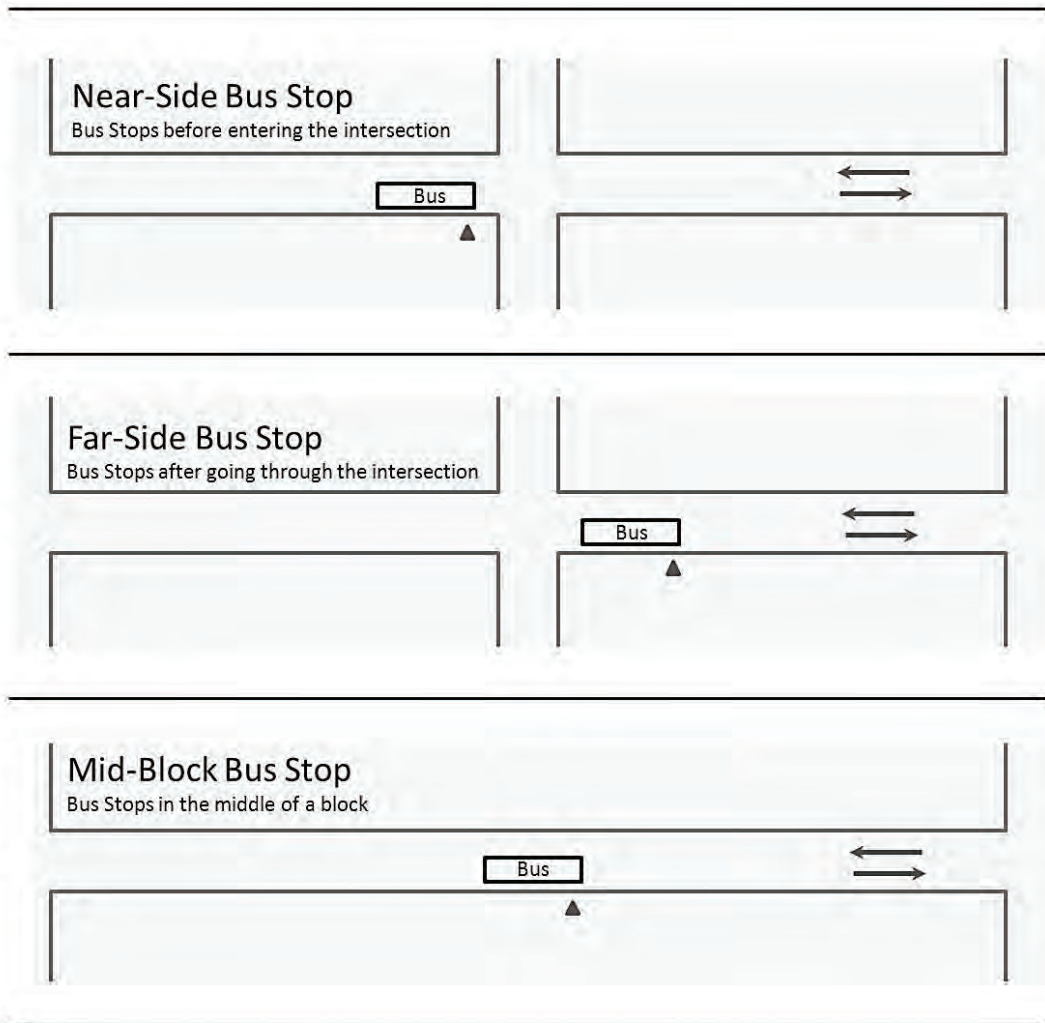
**Table 2 – Recommended Bus Stop Spacing**

| Environment   | Route Type                         | Spacing Range             |
|---|------------------------------------|---------------------------|
| Urban Area (within a City Plan Activity Center, see Figure 20 in Section 4.5) | Local Route                        | 1/8 – 1/4 Mile            |
|   | Express or Bus Rapid Transit Route | 1/2 – 1 Mile or As Needed |
| Suburban Area   | Local Route                        | 1/4 – 1/2 Mile            |
|   | Express or Bus Rapid Transit Route | 1 Mile or As Needed       |
| Rural Area  | Local Route                        | As Needed                 |
|   | Express or Bus Rapid Transit Route | As Needed                 |

### 3.3 STOP LOCATING

There are three location options for bus stops: near-side, far-side and mid-block, as shown in Figure 3 below. Far-side stops are, in general, Transfort’s preferred stop location because they are shown to be the safest for passengers exiting the bus and minimize conflicts with other vehicles. However, a mid-block or near-side stop may be more appropriate in some situations. Many factors influence the location of stops, such as site specific safety considerations, traffic patterns, intersection geometry, passenger origins and destinations, pedestrian accessibility, route design and available space. Transfort staff determine which stop location is most appropriate for each individual situation, and Table 3 may be used to help make a decision based on the trade-offs of each possible location.

Figure 3 — Near-Side, Far-Side and Mid-Block Stops Locations



**Table 3 — Recommended Bus Stop Location**

| STOP LOCATION   | ADVANTAGES   | DISADVANTAGES  |
|---|--|--|
| <p><b>NEAR SIDE STOP</b><br/>Use if:</p> <ul style="list-style-type: none"> <li>• Destinations are focused at the near-side corner</li> <li>• Route pattern calls for near-side location</li> <li>• Available space is limited on far-side</li> </ul> | <ul style="list-style-type: none"> <li>• Allows passengers to access buses close to the crosswalk</li> <li>• Eliminates the potential for double stopping — passenger loading can occur when bus is stopped at the signal</li> </ul>   | <ul style="list-style-type: none"> <li>• Increases conflict with right-turning vehicles</li> <li>• May result in stopping buses obscuring curbside traffic control devices and crossing pedestrians</li> <li>• May block the through traffic lanes during peak hours</li> <li>• May cause sight distance problems for pedestrians and motorists</li> <li>• May increase rear-end accidents if drivers aren't anticipating the bus stopping before the intersection</li> <li>• Vehicles may attempt to turn in front of a stopped bus that is beginning to pull away</li> </ul> |
| <p><b>FAR SIDE STOP</b><br/>Use if:</p> <ul style="list-style-type: none"> <li>• Destinations are on both sides of street or on the far side of the intersection</li> </ul>   | <ul style="list-style-type: none"> <li>• Minimizes conflicts between right-turning vehicles and buses</li> <li>• Allows for additional right-turn capacity (because bus is not stopping in the right turn lane)</li> <li>• Minimizes sight distance difficulties on approach to intersections</li> <li>• Encourages pedestrians to cross behind the bus</li> <li>• Bus can merge into traffic more easily, taking advantage of gaps</li> </ul> | <ul style="list-style-type: none"> <li>• Stopped buses may block intersections during congested periods</li> <li>• May cause a bus to stop twice in short order: once at a red light and once at the bus stop</li> <li>• May increase rear-end accidents if drivers do not anticipate the bus stopping after the intersection</li> </ul>   |
| <p><b>MID-BLOCK STOP</b><br/>Use if:</p> <ul style="list-style-type: none"> <li>• Block size is large and/or destinations are focused mid-block</li> <li>• Route pattern calls for mid-block stop</li> </ul>  | <ul style="list-style-type: none"> <li>• Minimizes sight distance difficulties at intersections</li> <li>• Removes the influence of traffic congestion occurring at intersections</li> </ul>   | <ul style="list-style-type: none"> <li>• Encourages passengers to cross mid-block (jaywalk)</li> <li>• Increases walking distance for patrons to cross at intersections</li> </ul>   |

## 3.4 IN-STREET DESIGN

The In-Street Design refers to the location that the bus stops in the street to approach the bus stop, such as in a bus pullout, travel lane, bike lane or on a road shoulder. Determining what design is appropriate depends on safety considerations, street design, available space, ridership and other factors. Most of Transfort's buses stop in bike or travel lanes, but bus pullouts may be used in areas where there is high ridership, a large number of route transfers or where traffic is considered to be high volume. Queue jumps refer to an intersection design that allows the bus to move ahead of queueing traffic to progress through high congestion intersections quicker. Queue jumps and bus pullouts typically originate from recommendations of a corridor, sub-area or service-related planning effort (e.g. Harmony Road Enhanced Travel Corridor Alternatives Analysis, Lincoln Corridor Plan, or West Central Area Plan). In addition, a bus pullout may be required when multiple routes transfer at the location. Foothills Mall provides an example of such a situation.

In-Street Design alternatives are illustrated below in Figures 4 and 5. Bus pullouts, shall be designed to the detail shown in LCUASS drawing 711. The flow chart in Figure 6 helps to determine what In-Street Design is appropriate, and the trade-off of each design is described in Table 4.

Figure 4 – In-Street Bus Stop Design Alternatives

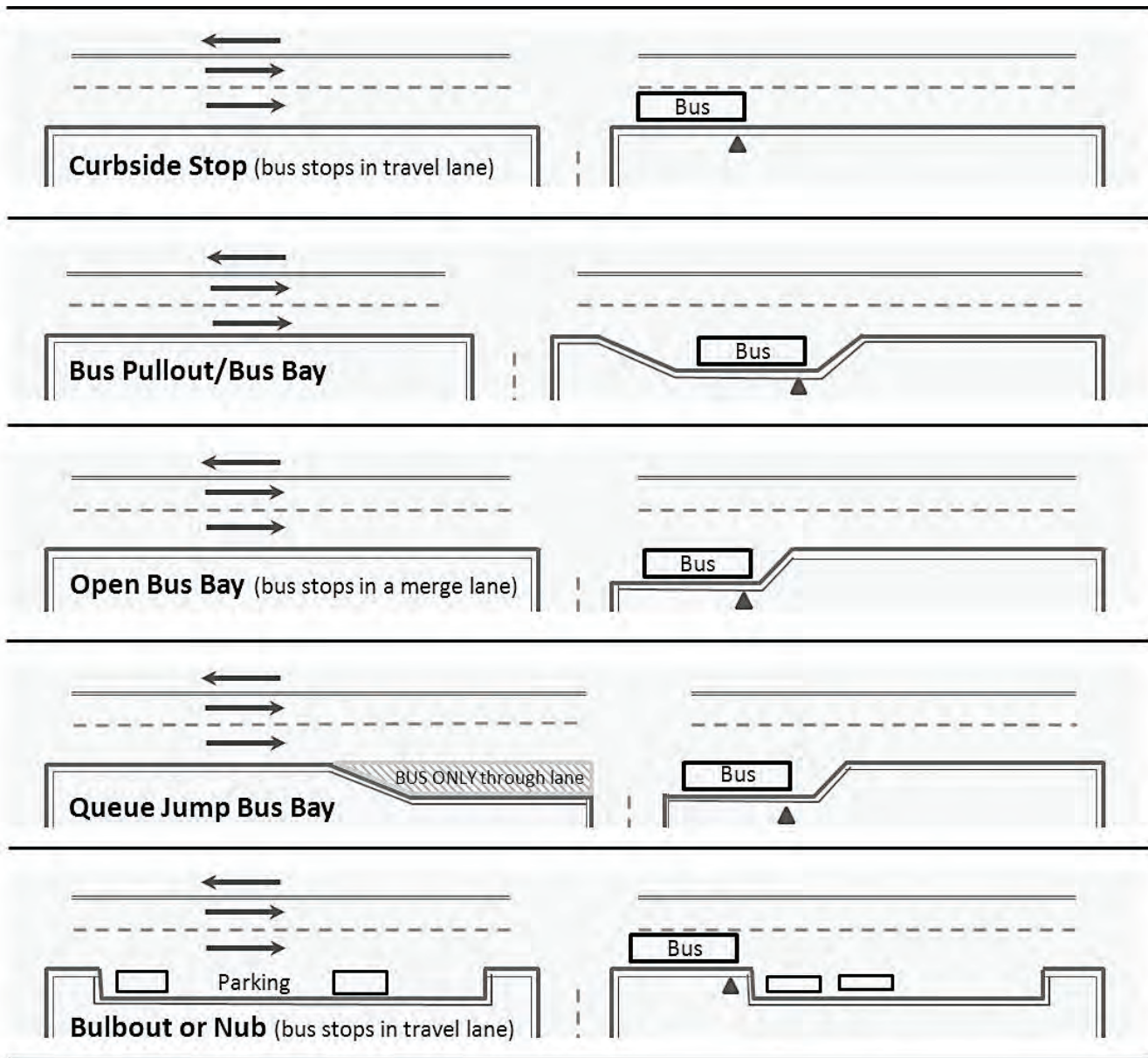
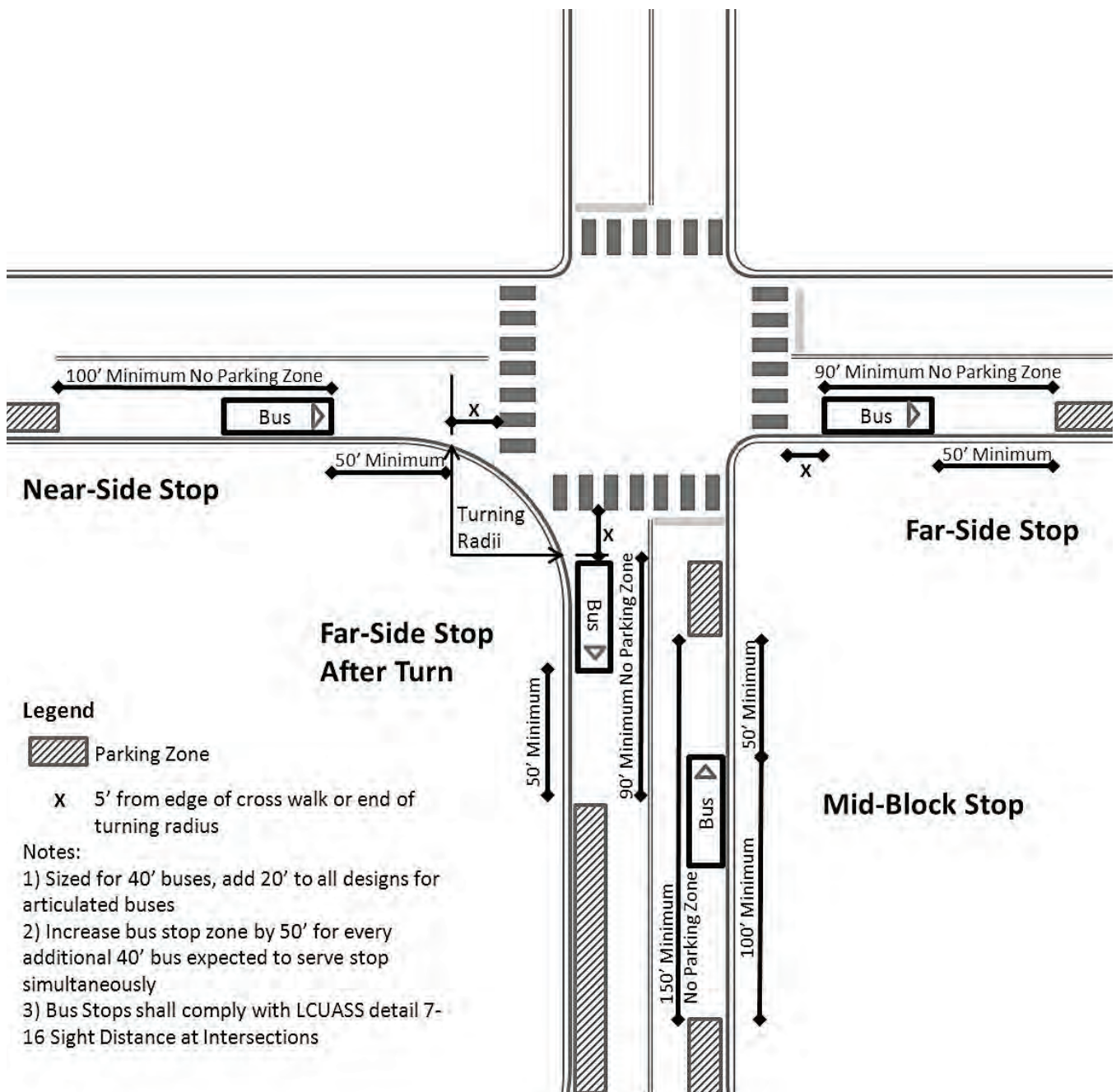
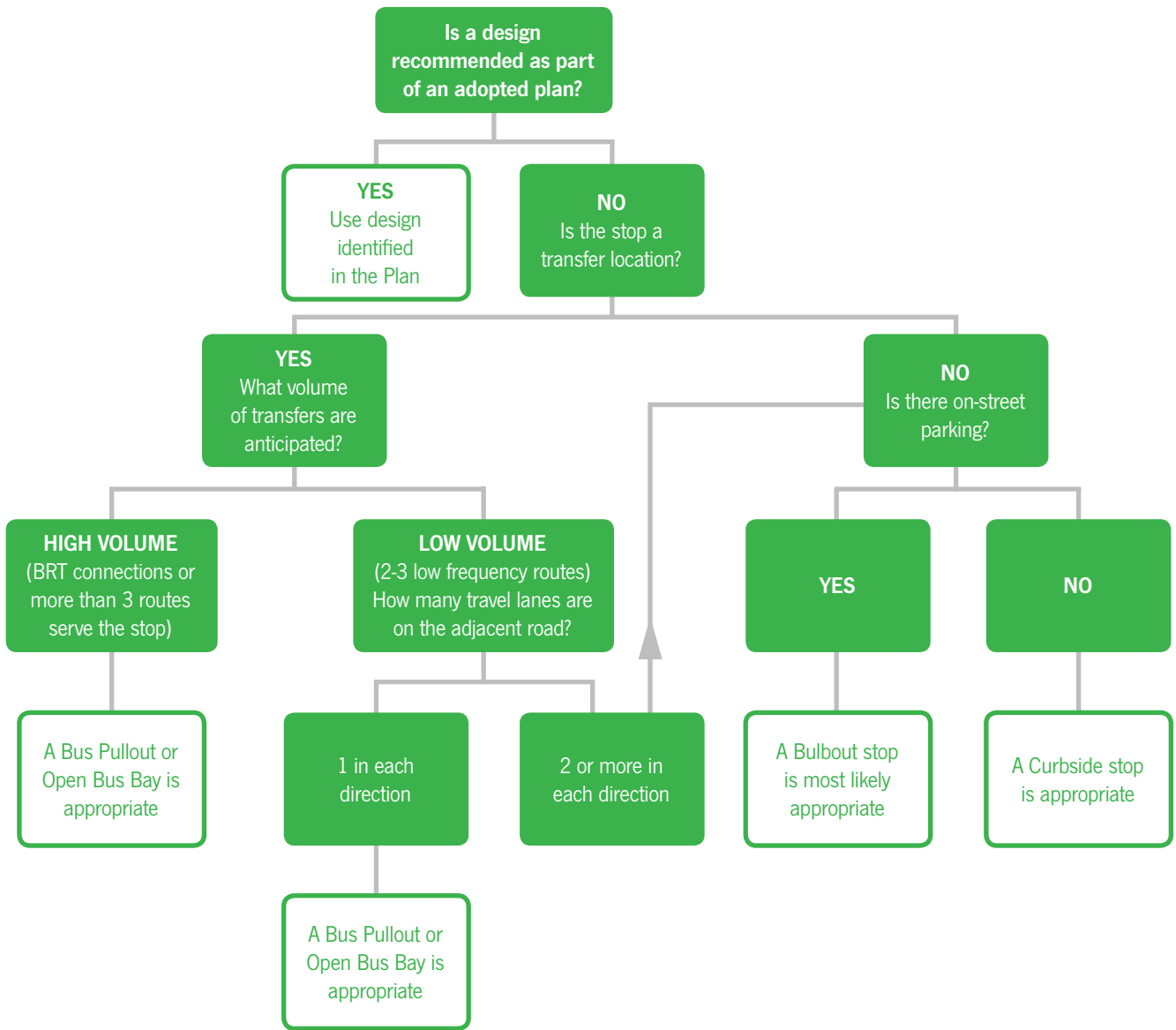


Figure 5 — Bus Stop Zone Dimensions (where on-street parking is present)



**Figure 6 – In-Street Design Recommendations**





**Table 4 – Recommended Bus Stop In-Street Design**

| STOP LOCATION   | ADVANTAGES   | DISADVANTAGES  |
|---|--|--|
| <b>CURBSIDE STOP</b><br>(Typical)   | <ul style="list-style-type: none"> <li>• Provides easy approach for bus drivers and results in minimal delay to the bus</li> <li>• Simple design and inexpensive to install</li> <li>• Easy to relocate</li> </ul>   | <ul style="list-style-type: none"> <li>• Can cause traffic delays since bus stops in the travel lane</li> <li>• May cause drivers to make unsafe passing maneuvers</li> </ul>                |
| <b>BUS PULLOUT</b><br>(Route transfer stop and/or on roads with two travel lanes) | <ul style="list-style-type: none"> <li>• Bus is out of travel lane, minimizing delay to traffic</li> <li>• Passengers board/alight out of traffic</li> </ul>   | <ul style="list-style-type: none"> <li>• Re-entry into congested traffic can be difficult and cause delays</li> <li>• Expensive to install, making relocation difficult/expensive</li> </ul> |
| <b>OPEN BUS BAY</b>   | <ul style="list-style-type: none"> <li>• Allows the bus to decelerate in the intersection</li> <li>• See Bus Pullout advantages</li> </ul>   | <ul style="list-style-type: none"> <li>• See Bus Pullout disadvantages</li> </ul>  |
| <b>QUEUE JUMP</b>   | <ul style="list-style-type: none"> <li>• Allows bus to bypass queued traffic</li> <li>• See Bus Pullout advantages</li> </ul>  | <ul style="list-style-type: none"> <li>• May delay right turning vehicles</li> <li>• See Bus Pullout disadvantages</li> </ul>  |
| <b>BULBOUT/NUB</b><br>(For locations with on-street parking)                      | <ul style="list-style-type: none"> <li>• Removes fewer parking spaces than others</li> <li>• Decreases walking distances to bus stops for pedestrians</li> <li>• Provides additional sidewalk area for passengers</li> <li>• Results in minimal delay for buses</li> </ul> | <ul style="list-style-type: none"> <li>• Costs more to install compared to curbside stops</li> <li>• See Curbside Stop disadvantages</li> </ul>  |

# 4. CURB-SIDE CHARACTERISTICS

## 4.1 INTRODUCTION

This section describes criteria that all bus stops shall meet, provides preferred layout of passenger amenities at stops and recommends how amenities should be distributed throughout the Transfort service area. Curbside characteristics refer to features associated with the comfort, safety and convenience of customers at bus stops outside of the roadway. These features include factors like sidewalk width, connections to adjacent land uses, and bus stop passenger amenities such as shelters, benches, bike racks, trash and recycling receptacles and lighting. Newly constructed or altered bus stops shall meet the standards in this section to the maximum extent feasible.

Image 9

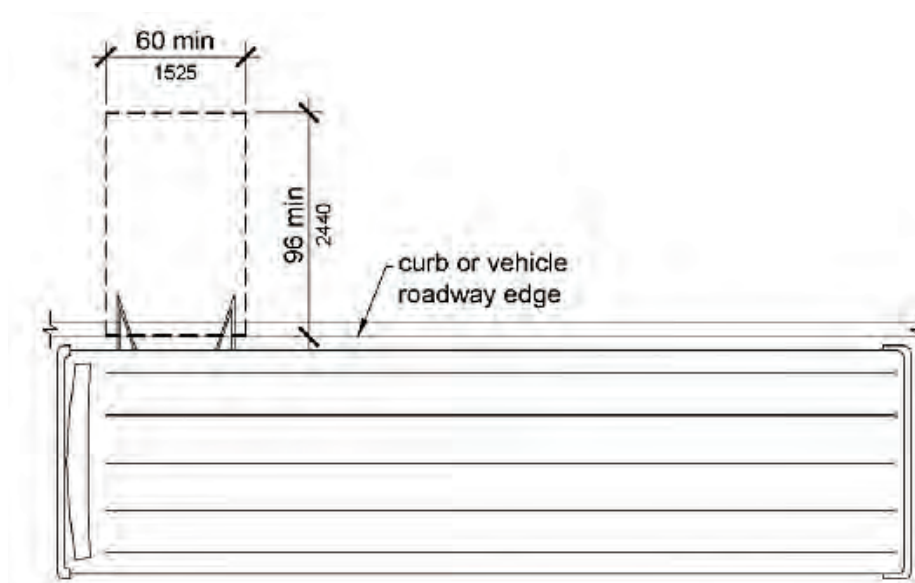


## 4.2 UNIVERSAL DESIGN AND ADA ACCESSIBILITY

The Americans with Disabilities Act of 1990 regulated enforceable accessibility standards for new construction and alterations to places of public accommodation, which include bus stops. The 2010 ADA Standards for Accessible Design, the most recent guidance, outlines the following four basic principles to accomplishing ADA accessibility at bus stops, as it applies to all newly constructed or altered Transfort bus stops.

- 1) **Surface** – the bus stop boarding and alighting area shall have a firm, stable surface;
- 2) **Dimensions** – the bus stop boarding and alighting area shall provide a clear length of 8' minimum, measured from the curb, and a clear width of 5' minimum, measured parallel to the roadway.

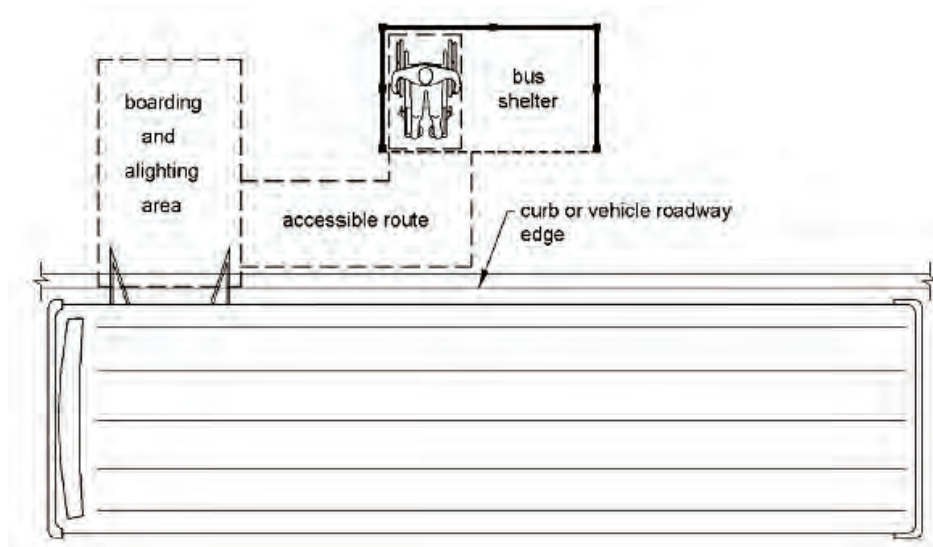
**Figure 6 – ADA Dimensions of Bus Boarding and Alighting Area**



- 3) **Connection** – the bus stop boarding and alighting area shall be connected to streets, sidewalks, or pedestrian paths by an accessible route, of at least 4' wide.
- 4) **Slope** – the slope of the bus stop boarding and alighting area shall be the same as the roadway to the maximum extent practical, and not steeper than 1:48, a 2% grade.

If a bus stop has a shelter, there shall be a minimum clear floor space of 30" wide by 48" deep inside the shelter and an accessible path leading from the shelter to the boarding and alighting area.

**Figure 7 – ADA Interior Bus Shelter Space**



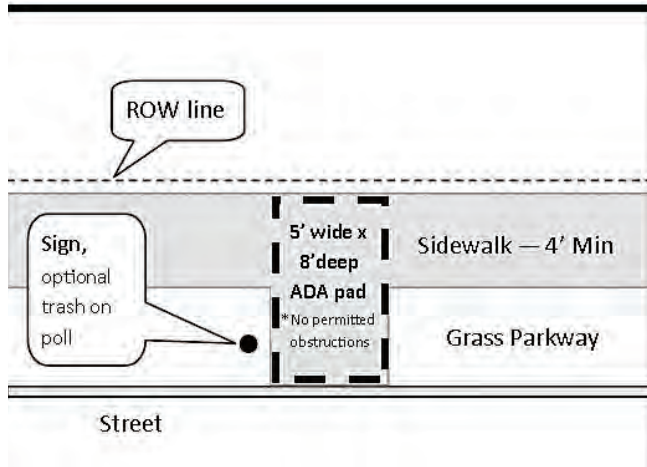
## 4.3 BUS STOP TYPES

Transfort has four typical stop types tailored to the context of each stop area. Higher ridership areas or areas with high concentrations of youth, senior, disabled or low-income populations are recommended to have a higher level of patron amenities such as a shelter, bench, bike rack, trash receptacle and lighting. Lower ridership areas may have fewer amenities. The Bus Stop Development Form (Appendix 1) will assist in determining what stop type is appropriate. The stop types are described below:

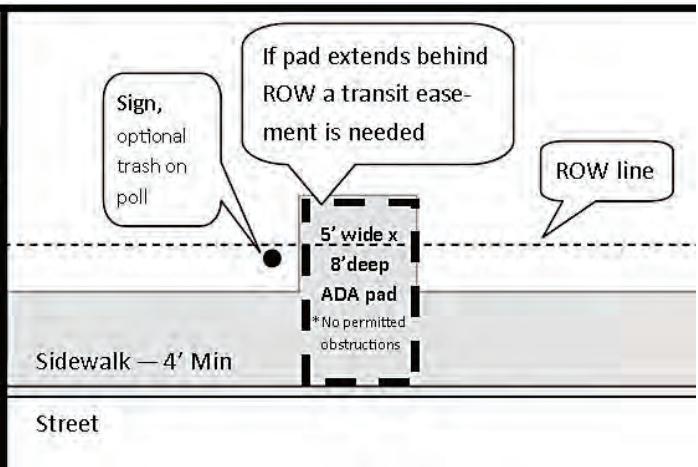


- Type I – Sign Stop** – A bus stop with a bus stop sign and basic ADA accessible landing surface are the primary features of this stop type, meaning there is no bench or shelter. This is the most basic stop type and is appropriate for low land-use density and low ridership areas. Figures 8 and 9 and images 10 and 11 show standard and constrained options for this type of stop, depending on the available right-of-way and sidewalk design.

**Figure 8**  
**Type I Standard** (Detached sidewalk)



**Figure 9**  
**Type I Constrained** (Attached sidewalk)



**Images 10 and 11 – Existing Type I Standard Stop Examples:**



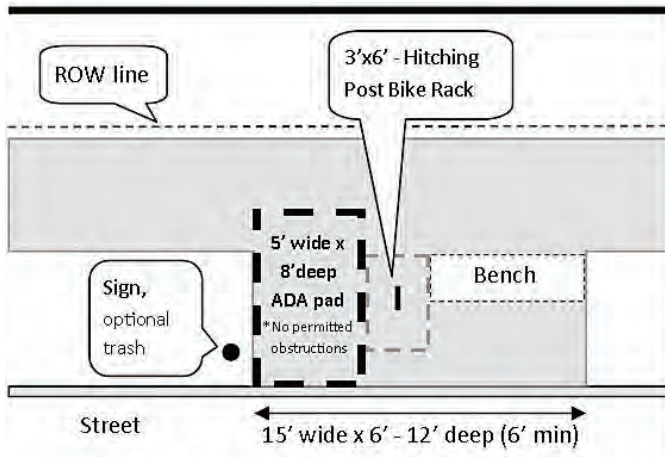
**Shields and Rolland Moore Park SB Bus Stop**



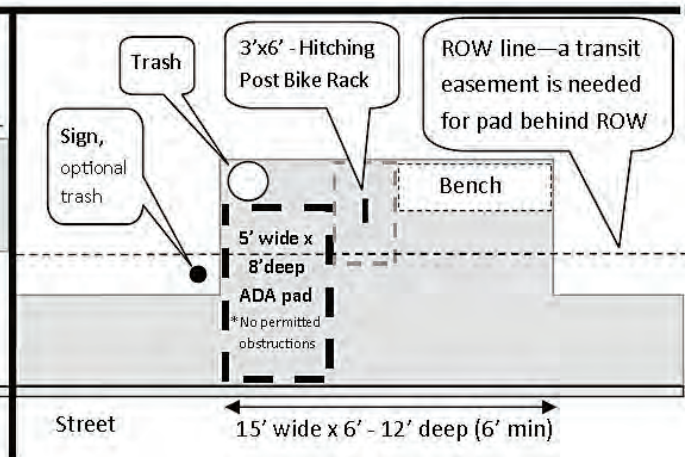
**Harmony and Taft Hill EB Bus Stop**

- **Type II – Bench Stop** – This describes a bus stop with a stand-alone bench as the primary feature, and which does not include a shelter. The stop should also have a bus stop sign, bike rack and trash receptacle. The most appropriate use of Bench Stops is areas with low to mid ridership potential. Figures 10 and 11 and images 12 and 13 show standard and constrained options for Type II – Bench Stops.

**Figure 10**  
Type II Standard (Detached sidewalk)



**Figure 11**  
Type II Constrained (Attached sidewalk)



**Images 12 and 13 – Existing Type II Standard and Constrained Examples**

(to comply with above design, these stops need the addition of a bike rack and trash receptacle)



**Shields and Centre Avenue NB Bus Stop**

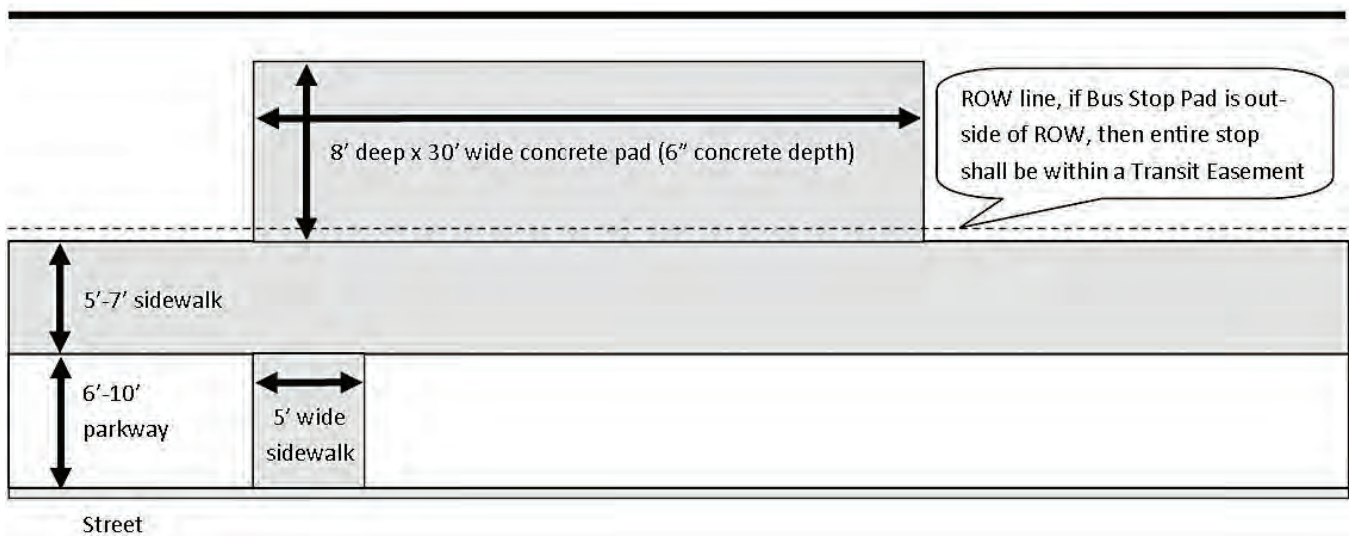


**Lincoln Avenue and Buckingham Park WB Bus Stop**



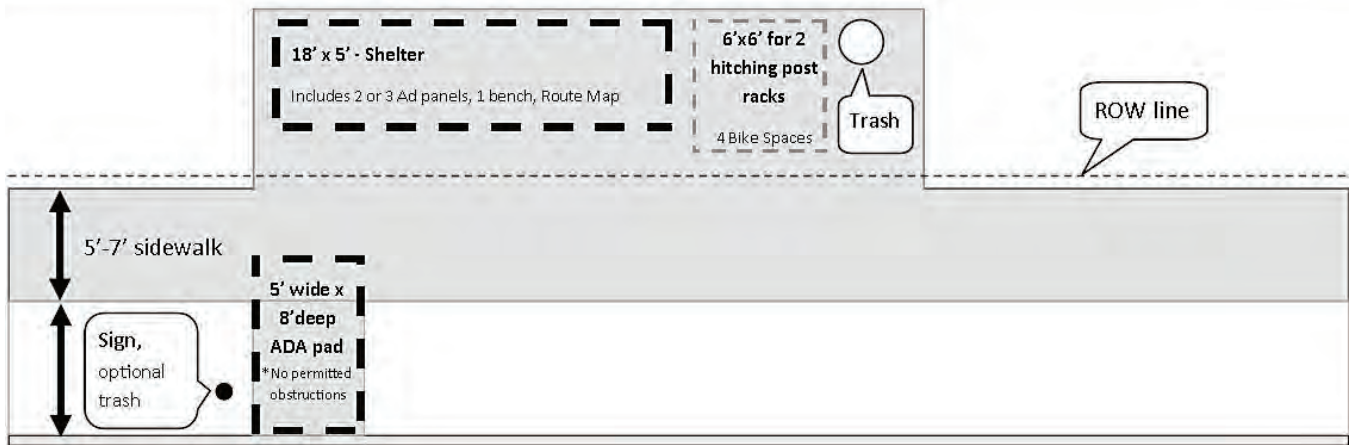
- Type III – Shelter Stop** – This describes a bus stop with a shelter as the primary feature. This stop type should also include a bus stop sign, at least one bench, a trash receptacle, one or more bike racks, interior lighting and advertising panels. A Shelter Stop should be used in areas with medium to high ridership potential, high concentrations of elderly, youth, disabled and low-income populations and in areas with high exposure to the elements.
  - There are four alternative designs for Type III stops. The alternative chosen depends on the sidewalk design, public right-of-way and existing structures that may render the standard design impractical. Transfort staff will assist in determining which design is appropriate for each individual situation. Figures 12–19 and images 14–17 show examples of Type III Shelter Stop configurations. The existing stop images aren’t necessarily compliant with the organization/siting recommendations for passenger amenities in this section, for the appropriate organization/siting of passenger amenities, see the “amenity detail” following each Type III configuration.

**Figure 12**  
**Type III Standard** (Detached sidewalk)

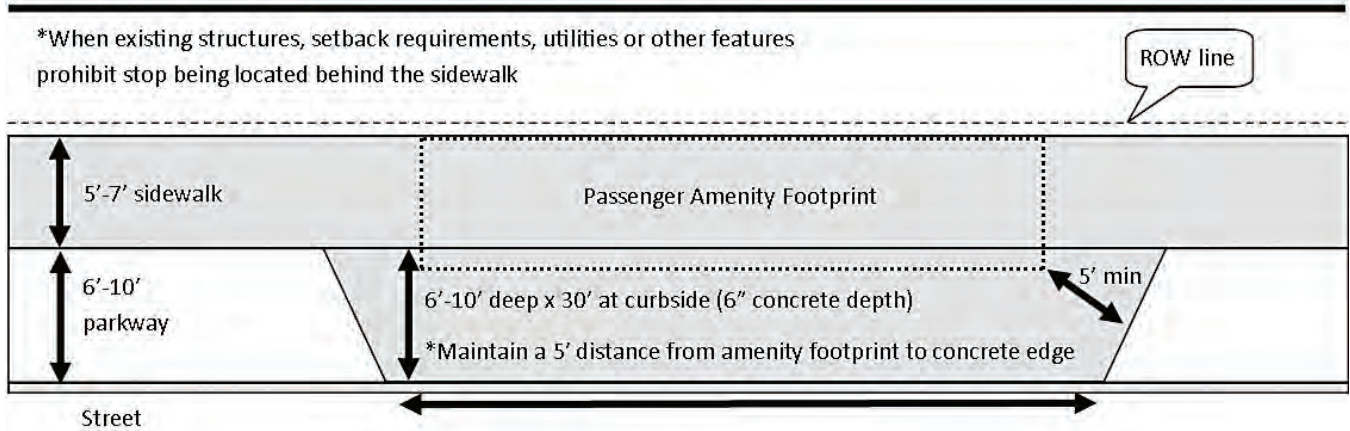




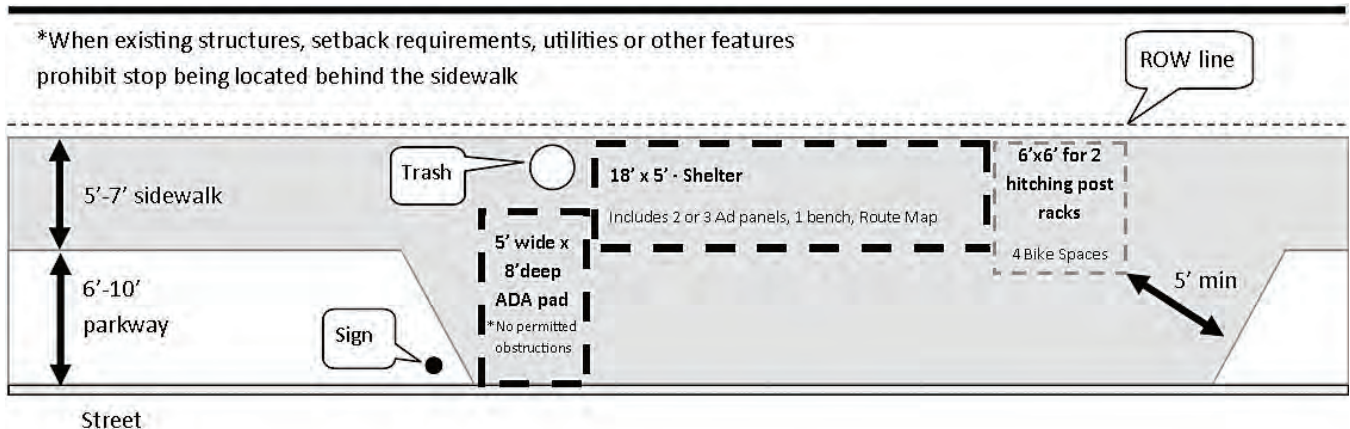
**Figure 13**  
**Type III Standard** (Detached sidewalk) – Amenity Detail



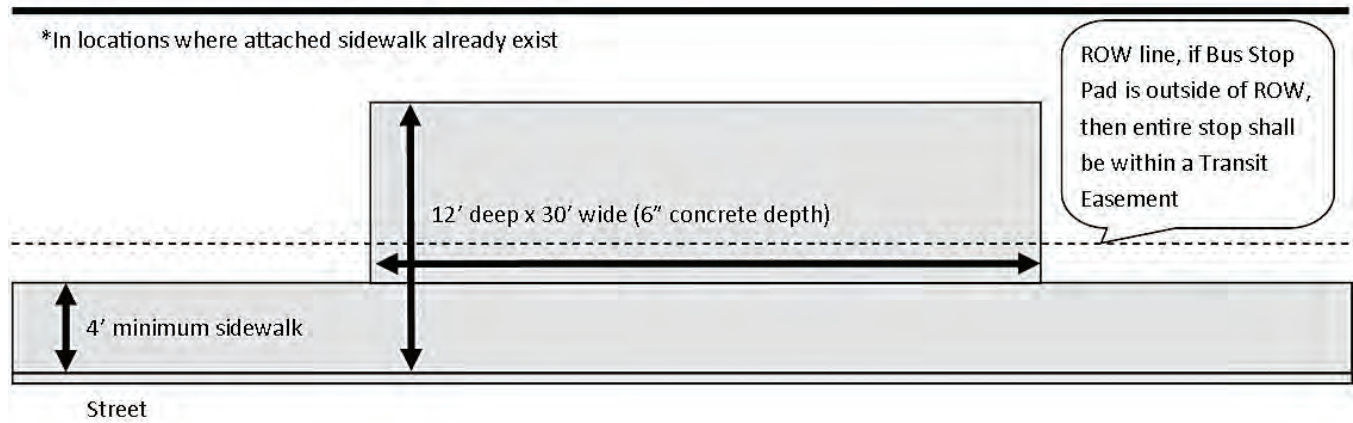
**Figure 14**  
**Type III Constrained** (Detached sidewalk)



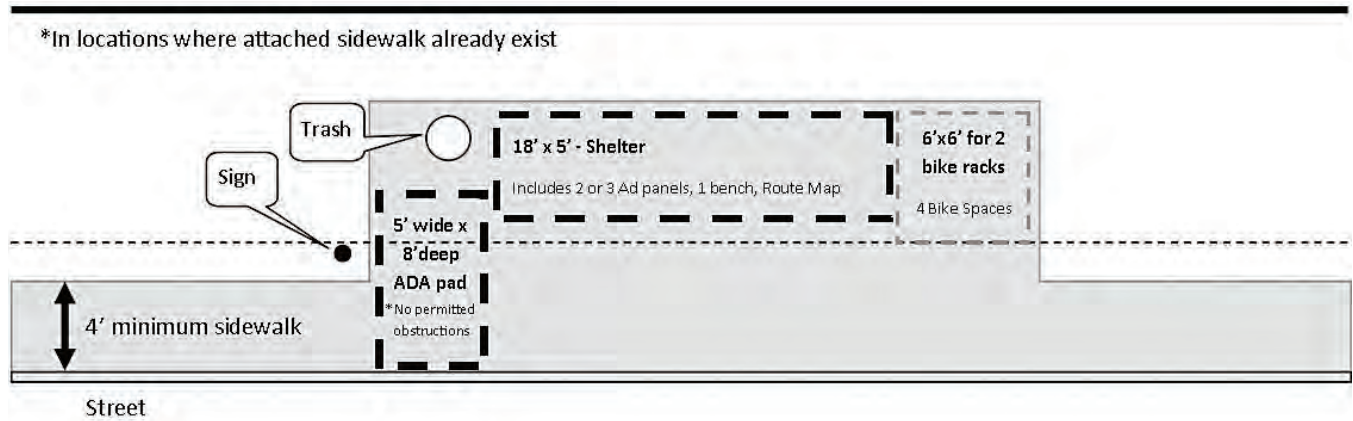
**Figure 15**  
**Type III Constrained** (Detached sidewalk) – Amenity Detail



**Figure 16**  
**Type III Constrained (Attached sidewalk)**



**Figure 17**  
**Type III Constrained (Attached sidewalk) – Amenity detail**



**Figure 18**  
**Type III Wide Parkway (Detached sidewalk)**

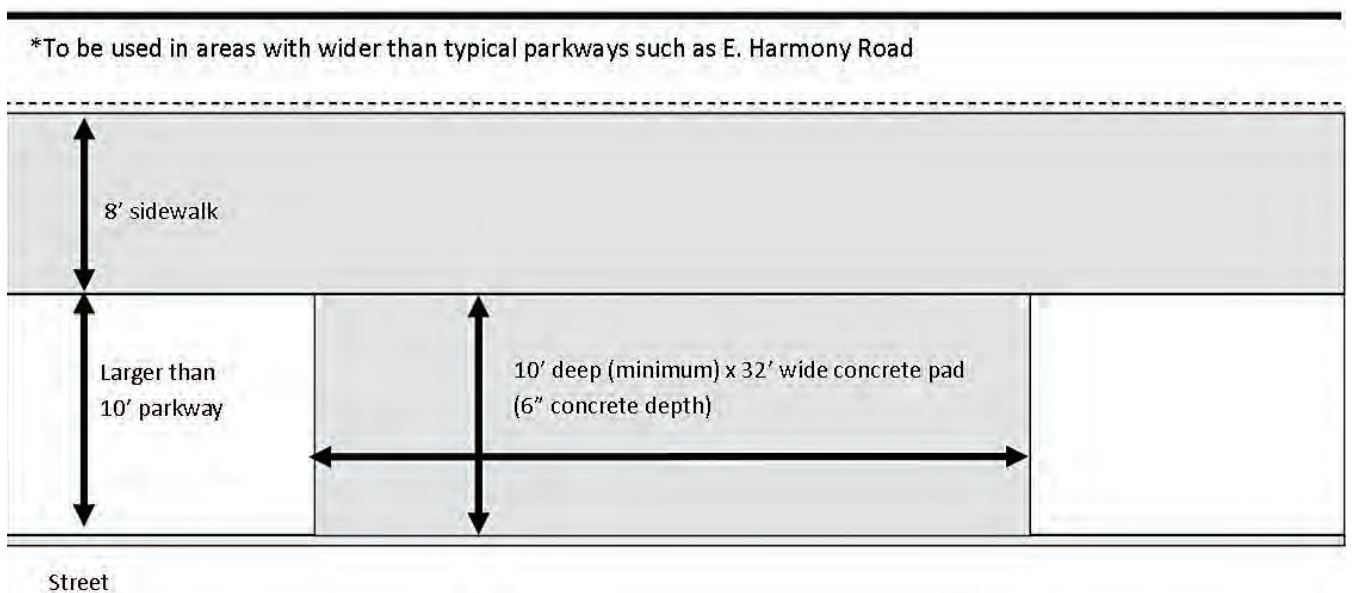




Figure 19

Type III Wide Parkway (Detached sidewalk bus stop) – Amenity detail

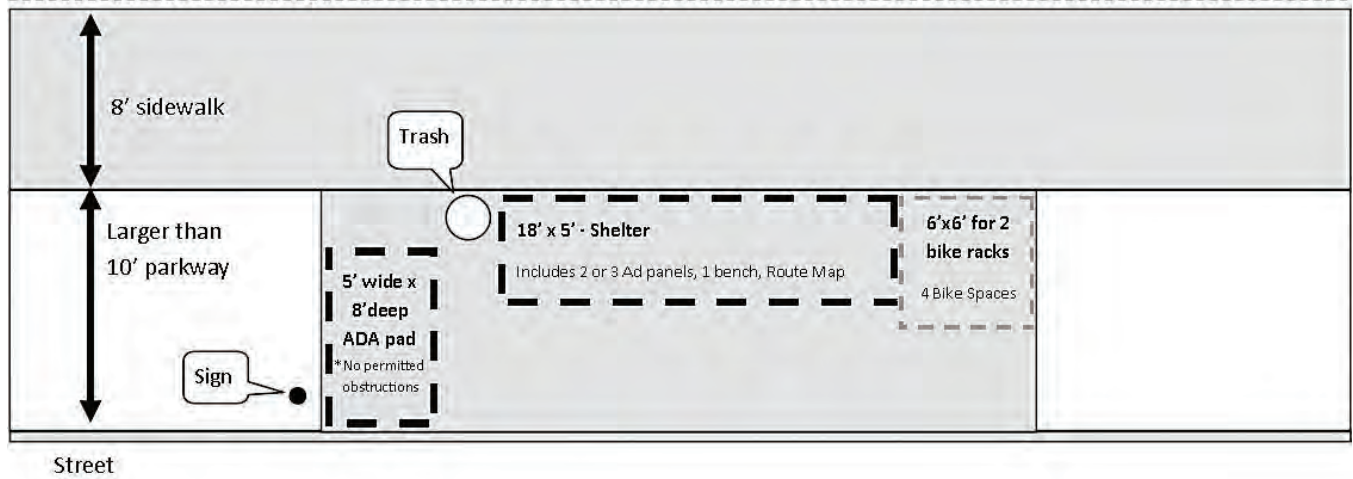


Image 14 and 15 Existing Type III Examples



\*These do not meet the siting/organization of passenger amenity recommendations detailed in this section. Over time stops will be upgraded to meet revised standards, see Section 5.2 for more information.

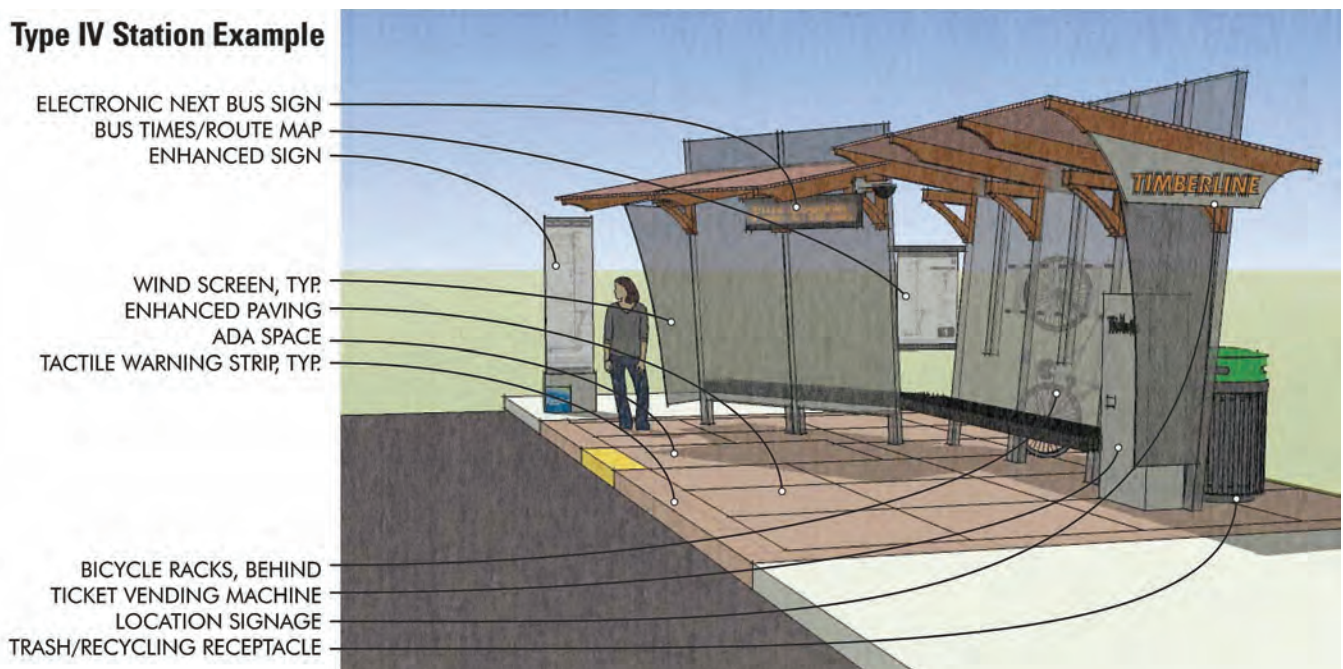
Images 16 and 17 – New Shelter Examples



- Type IV – Station Stop** – This describes a bus stop that has enhanced passenger amenities such as a ticket vending machine, real time next bus LED and/or digital signage, a unique shelter structure, as well as the standard passenger amenities provided at Type III stops. Elements required at a Station Stop include those identified in Image 18 and Section 4.4 below. MAX Stations are currently the only Station Stops in Transfort’s system. Stations should be used on specialty routes, most often in Enhanced Travel Corridors as defined in the Transportation Master Plan as “uniquely designed corridors that are planned to incorporate high frequency transit, bicycling and walking as part of the corridor.”

**Image 18 – Example Station Stop**

**Type IV Station Example**



**Image 19 – Troutman Station (Concept)**



**Image 20 – Troutman Station (Built)**





## 4.4 PASSENGER AMENITIES

Passenger amenities are a significant element in attracting people to use public transportation. Shelters are the most preferred passenger amenity because they offer the best protection from the elements. Other important amenities include: benches; customer information such as transit maps; real-time bus arrival information and directional signage; lighting; bike racks; and trash and recycling facilities. All passenger amenities should be located within public right-of-way or within a dedicated transit easement. The Bus Stop Passenger Amenities required, based on Stop Type described in Section 4.3, are provided in Table 5. In addition, see the Bus Stop Development Form in Appendix 1 for determining stop type.

- **Bus Stop Sign** – All active bus stops (except Type IV Station Stops) are required to have a Transfort bus stop sign. Signage includes a round bus stop sign and a routes served sign. Transfort will arrange for the installation of the signage at the time service is initiated at a stop.
- **Solid Surface and full ADA Accessibility** – All newly constructed or altered bus stops shall have a solid surface at least as large as the minimum size described in the Stop Types in Section 4.3 and comply with the four dimensions of accessibility described in Section 4.2. Newly implemented routes offer an exception to this rule, as sometimes stop locations need to be monitored to ensure they are in the best location prior to making the full investment upgrading the stop infrastructure. Final stop locations are generally finalized within two years.
- **Bench** – All new benches shall be selected from the options described in this section and shall be powder coated in either RAL 7047 (for benches in shelters) or RAL 7039 (for stand-alone benches), refer to the Shelter Paint Colors on page 31. Images 21-23 depict the acceptable options.

Image 21



6' Stand-alone ad bench  
REF RFB-14 4793-121

Image 22



5–7' In-shelter non-ad bench  
REF SFB-02 14001-121

Image 23



5' In-shelter non-ad bench  
REF SFB-08 12096-121



- **Shelter** – All new shelters (not including Type IV Stations) shall be selected from the options described in this section and be powder coated in RAL 7047 and RAL 6017 as depicted in the examples below. Walls shall be either perforated metal or custom glass with the official Transfort branded banner and routes served information as shown in images 24–27. A double-sided advertising panel is the standard requirement. The non-ad shelter option is only available upon Transfort’s approval. In addition, shelters are preferred to incorporate solar panels for lighting or shall be directly wired for electric service.

**Image 24**



**15' Standard advertising shelter**  
REF SIGA-TFP15 25340-00

**Image 25**



**14' Standard Non-advertising shelter**  
(Use must be approved by Transfort)  
REF SIGNA-TFP14

**Image 26**



**15' Upgraded ad shelter with glass walls**  
REF SIGA-TFG15 25341-00

**Image 27**



**18' Upgraded ad shelter with V-ad Panels**  
REF SIGA-TFV 24343

# SHELTER PAINT COLORS

RAL Paint Colors

GREEN: #RAL 6017

SILVER: #RAL 7047





- **Bike Racks** – Bike racks are recommended at all bus stops and specifically required at all type II–IV stops. The preferred bike rack style is a simple hitching post or inverted U, as shown below, and should be powder coated in RAL 7047, RAL 7039 or RAL 6017.

**Image 28** (2 bike)



REF SFM-05 25390-121

**Image 29** (2 bike)



REF SFM-06 25391-121

**Image 30** (4 or 5 bike)



REF SFM-10 25392-121

- **Trash and Recycling Receptacles** – Trash and recycling receptacles are required at all Type III and IV stops and are an option at Type I and II stops. Lower ridership stops may utilize a pole mounted trash receptacle, and higher ridership stops (projected over 25 daily boardings) shall provide a stand-alone trash receptacle from the options below, and should be powder coated in RAL 7047 or RAL 7039.

**Image 31**



**Pole Mounted**

REF SFTR-10 25393-121 25394-121

**Image 32**



**32 Gallon Steel Strap**

REF SFTR-11 25395-121 25396-121

- **Lighting** — Solar lighting panels are included on the roof of the approved shelter options described previously. Type I and II stops typically do not have their own lighting, and instead utilize nearby street lights and lighting from neighboring businesses. Pole mounted lighting may be an option for stops with limited nearby lighting.
- **Transit System Map** — Transfort installs transit system maps at high ridership Type III stops (over 50 daily boardings). System maps are only installed at Type III stops because the shelter provides a mounting location for the map display case.
- **Transit Route Map/Schedules(s)** — Transfort typically installs individual route maps at high ridership Type III stops (over 50 daily boardings). Route maps are only installed at Type III stops because the shelter provides a mounting location for the map display case.
- **Ticket Vending Machine (TVM)** — Ticket vending machines are included at MAX stations and in the example Type IV Station Stop design, as shown in Images 18–20. However, while TVMs remain a recommended element, the need for TVMs may be reduced as Transfort moves towards mobile ticket purchase options.
- **Digital Signage** — Digital signage is recommended at all Type IV Station Stops and may be installed by Transfort at high use and/or transfer bus stops. Digital signs, which are LED panels and/or LCD screens, typically display real-time bus arrival information, rider alerts, and other critical passenger information.
- **Ground Mounted Tactile** — Type IV Station Stops are recommended to include ground mounted tactile surfaces adjacent to boarding and alighting areas.
- **Paper Schedules** — Paper schedules are typically provided just at transit centers, but could be considered for high ridership stops as needed. This information would be provided by Transfort.
- **Security Cameras and Emergency Call Box** — Security cameras and emergency call boxes are recommended to be provided at Type IV Station Stops.
- **Wind Screen** — Wind screens are integrated into the standard shelter designs, but depending on the orientation of the shelter, the standard wind screens may not be adequate for the specific location. If wind is deemed to be an issue at a particular stop, a custom wind panel should be considered in addition to or in lieu of the standard shelter wind panel.



- **Secure Bike Parking** — Secure bike parking is an optional element at any stop, but should be considered at high use stops, especially transit centers and/or park-n-rides.
- **Braille Signage** — Braille signage is not a standard element at bus stops, but has been recommended to be evaluated further following the completion of this document. Section 5.3 discusses next steps related to Braille Signage.
- **Wayfinding Signage** — Wayfinding signage is optional at all bus stops but is recommended at Type IV Station stops.

**Table 5 — Bus Stop Amenities**

| Bus Stop Amenities  | Type I   | Type II     | Type III    | Type IV     |
|---|----------|-------------|-------------|-------------|
| Bus Stop Sign   | Required | Required    | Required    | Recommended |
| Solid Surface   | Required | Required    | Required    | Required    |
| 5' x 8' Landing Pad   | Required | Required    | Required    | Required    |
| 4' Path Connection to adjacent sidewalks  | Required | Required    | Required    | Required    |
| Minimal Slope   | Required | Required    | Required    | Required    |
| Bench   | Optional | Required    | Required    | Required    |
| Shelter   | Optional | Optional    | Required    | Recommended |
| Custom Shelter  | Optional | Optional    | Optional    | Recommended |
| Bike Rack(s)<br>(At least 1 rack recommended at all stops [except Type I], additional racks may be required based on projected ridership) | Optional | Required    | Required    | Required    |
| Trash and Recycling Facilities  | Optional | Recommended | Required    | Required    |
| Lighting  | Optional | Optional    | Recommended | Required    |
| Transit System Map  | Optional | Optional    | Recommended | Recommended |
| Route Map/Schedule(s)   | Optional | Optional    | Recommended | Recommended |
| Ticket Vending Machine (TVM)  | Optional | Optional    | Optional    | Recommended |
| Digital Signage   | Optional | Optional    | Optional    | Recommended |
| Ground Mounted Tactile  | Optional | Optional    | Optional    | Recommended |
| Paper Schedules   | Optional | Optional    | Optional    | Optional    |
| Security Cameras and Emergency Call-box   | Optional | Optional    | Optional    | Recommended |
| Wind Screen   | Optional | Optional    | Recommended | Required    |
| Secure Bike Parking   | Optional | Optional    | Optional    | Optional    |
| Braille Signage   | Optional | Optional    | Optional    | Optional    |
| Wayfinding Signage  | Optional | Optional    | Optional    | Optional    |

**Legend:**

- Required Amenity
- Recommended Amenity
- Optional Amenity

# 4.5 BUS STOP TYPE DETERMINATION

The selection of the appropriate stop type should consider both qualitative and quantitative measures, such as:

- ridership potential and/or existing ridership,
- neighboring land uses, including concentrations of youth, seniors, disabled, and low-income populations (e.g. schools, housing or social service agencies)
- proximity to defined activity centers (as part of City Plan), and
- exposure to the elements.

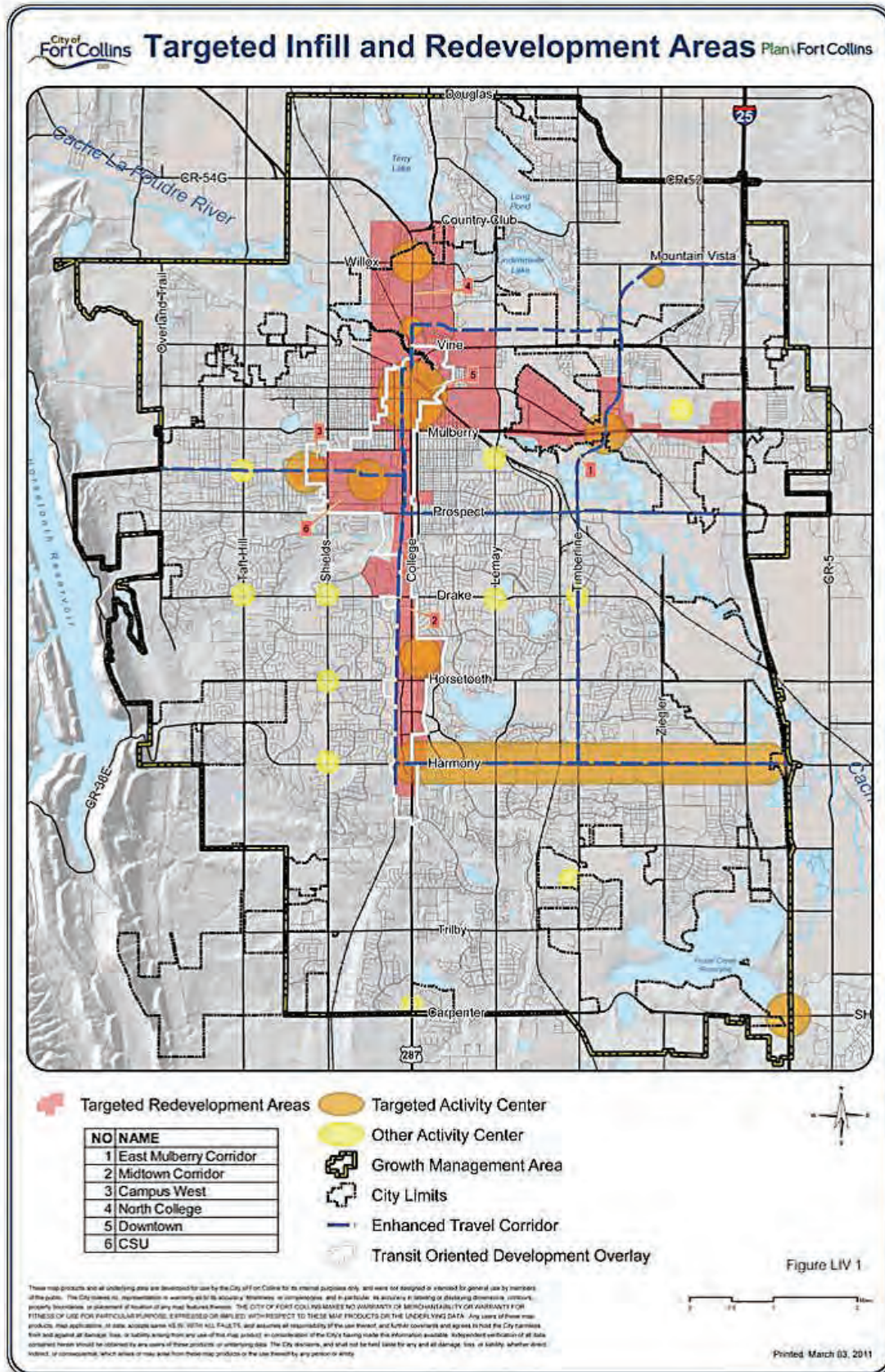
As new stops are developed, the following criteria should be used to determine the appropriate stop type. Please refer to the Bus Stop Development Form in Appendix 1 for a site specific evaluation form.

Higher priority for upgrades should be given to bus stops with mid-high ridership (above 50 boardings per day), demographic considerations such as youth, senior, disabled and low-income population concentrations within ¼ mile of the stop, and stops with high exposure to the elements.

**Table 6 – Bus Stop Type Criteria**

| Criterion   | Type I – Sign                                 | Type II – Bench                                     | Type III – Shelter                                    | Type IV – Station                                    |
|---|---|---|---|--|
| <b>Ridership Potential</b><br>(existing or projected)   | <b>Low Ridership</b><br>(<25 daily boardings) | <b>Low-Med Ridership</b><br>(25–50 daily boardings) | <b>Med-High Ridership</b><br>(>50 daily boardings)    | <b>Very High Ridership</b><br>(250+ daily boardings) |
| <b>Land Use Density</b><br>(Refer to Zoning Map)  | <b>RUL, UE, RF, RL, or POL</b>                | <b>NCL, NCB, LMN, RC, RDR, NC, CL, E, I</b>         | <b>NCM, MMN, HMN, D, CC, CCN, CCR, CG, CS, HC</b>     |  |
| <b>Youth, Seniors or Disabled Populations Concentrations</b>  |   |   | <b>Within a 1/8 mile of population concentrations</b> |  |
| <b>Located in an Activity Center</b> (City Plan– Targeted Infill and Redevelopment Area map, see Figure 20 below) |   |   | <b>Recommended</b>                                    |  |
| <b>Located in an Enhanced Travel Corridor</b>   |   |   | <b>Recommended</b>                                    |  |
| <b>High Exposure to the Elements</b>  |   |   | <b>Recommended</b>                                    |  |

Figure 20 – Targeted Infill and Redevelopment Map, City Plan, 2010



# 5. NEXT STEPS

---

## 5.1 INTRODUCTION

As noted previously, Transfort serves just over 500 bus stops; some of which meet the design and amenity distribution standards outlined in Sections 3 and 4. This section is intended to describe Transfort's plan to bring bus stops into compliance with these standards as well as the City's Americans with Disabilities Act Transition Plan as adopted in 1992.

The Transition Plan set forth a five year approach to achieving full compliance with the Americans with Disabilities Act standards. At that time, Transfort had a much smaller service area and anticipated that full compliance could be achieved through a \$17,000 investment in bus stop solid surface improvements. The plan presumed that once existing stops were brought into compliance, future stops would be developed in accordance with the ADA standards. However, that was not the case and many of Transfort's current stops are not compliant with ADA standards.

In 2013, a full inventory of bus stops was completed. This identified that only 32% of Transfort's stops met the ADA standards described in Section 4.2. Since 2013's inventory, service has been eliminated in some areas (College Avenue and Timberline Road) and new service has been added to other areas (Mason Corridor, North Timberline Road, West Vine Drive, East Drake Road and East Horsetooth Road). In addition, as of spring 2015, approximately 50 stops had been upgraded to meet ADA standards. Transfort managed projects upgrading 27 stops, including 18 MAX stations and nine stops throughout the community; private development upgraded upwards of seven stops; and Transfort's advertising contractor upgraded 16 stops. Based on this information Transfort estimates that now approximately 35% of bus stops meet ADA accessibility requirements. Inventorying of bus stops is ongoing and Transfort will have a more accurate understanding of ADA compliance by the end of 2015.

Based on the previous estimate, approximately 330 bus stops in Transfort's service area are not in compliance with ADA standards. Many of these are located in areas with limited neighborhood sidewalks. In addition to the cost of any necessary connecting sidewalks, bus stop improvements can range between \$2,500 to \$30,000 depending on the available public ROW and other site specific characteristics (an average is estimated at \$10,000 for each stop). Stops on the low



end are generally within public ROW and have level grading to build on. Stops on the higher end are in areas that often require negotiations with private property owners before any accessible infrastructure can be installed and where drainage or grading challenges are present. The obstacles to upgrading bus stops is described more thoroughly in Section 2.4.

This information leads Transfort to estimate that full compliance with ADA standards would cost between \$3,000,000 and \$5,000,000 (in 2015 dollars). Transfort's Bus Stop Improvement Plan, in Section 5.2, describes Transfort's phased approach to achieving (at a minimum) ADA accessibility at all bus stops as well as compliance with the bus stop type and amenity distribution standards in this document.

Section 2.3 – “Bus Stop Installation and Upgrade – How does it happen?” explains the four primary ways that bus stops are upgraded:

- Transfort Bus Stop Improvement Plan
- Transfort's Advertising Contractor
- Development and/or Redevelopment
- City Capital Projects and Street Maintenance Program

This section focuses on stops improved through the Transfort Bus Stop Improvement Plan and by Transfort's advertising contractor. Transfort's Bus Stop Improvement Plan is not all inclusive of every Transfort stop, since two other improvement methods, Development/Redevelopment and City Capital Projects – Street Maintenance Projects, will also result in upgraded stops throughout the community.

## 5.2 TRANSFORT BUS STOP IMPROVEMENT PLAN

This April, City of Fort Collins residents approved a 10-year 0.25% sales tax for Capital Projects. In addition to other City Capital Projects, this tax includes a dedication of an average of \$100,000 a year to bus stop improvements in the Transfort service area. It is anticipated that this will fund an average of 10 stops a year over the next 10 years for a total of 100 stops (between 2016 and 2026). This

funding can also serve as local as leverage for grants for additional stop improvements. In addition, Transfort can work with their advertising contractor to upgrade additional stops within public ROW.

Based on this identified funding source and Transfort's working relationship with their advertising contractor, Transfort projects an average of 15–20 stops be improved to meet the new design standards each year based on the priorities described in Section 4.5. To reiterate, priority for bus stop upgrades are given to areas that do not meet ADA requirements and meet the following criteria:

- Mid-high ridership (above 50 boardings per day),
- Demographic considerations such as youth, senior, disabled and low-income population concentrations within ¼ mile of the stop
- Stops with high exposure to the elements

## 5.3 RECOMMENDED FUTURE ACTIONS

- **Grant Funding** — The City should pursue grant funding to leverage the limited local funding to accelerate the Transfort Bus Stop Improvement Plan.
- **Snow Removal on Adjacent Sidewalks** — The inconsistent removal of snow surrounding bus stops was a point of concern for the Citizen Advisory Committee that helped guide the development of this document. Transfort would not be the appropriate leader to initiating this discussion, but the City's Street Maintenance and Code Enforcement Departments will be made aware of the concerns expressed.
- **Braille Signage** — Braille signage was identified as an element of interest by the Citizen Advisory Committee that guided the development of this document. Following the adoption of this document, Transfort will establish a group of interested transit users to help determine how Braille signage could be implemented and what the Braille signage should say.

# 6. APPENDIX

---

THIS PAGE INTENTIONALLY LEFT BLANK

# 6.1 BUS STOP DEVELOPMENT FORM

## Transfort Bus Stop Checklist

To be filled out by Transfort Staff

**TRANSFORT**

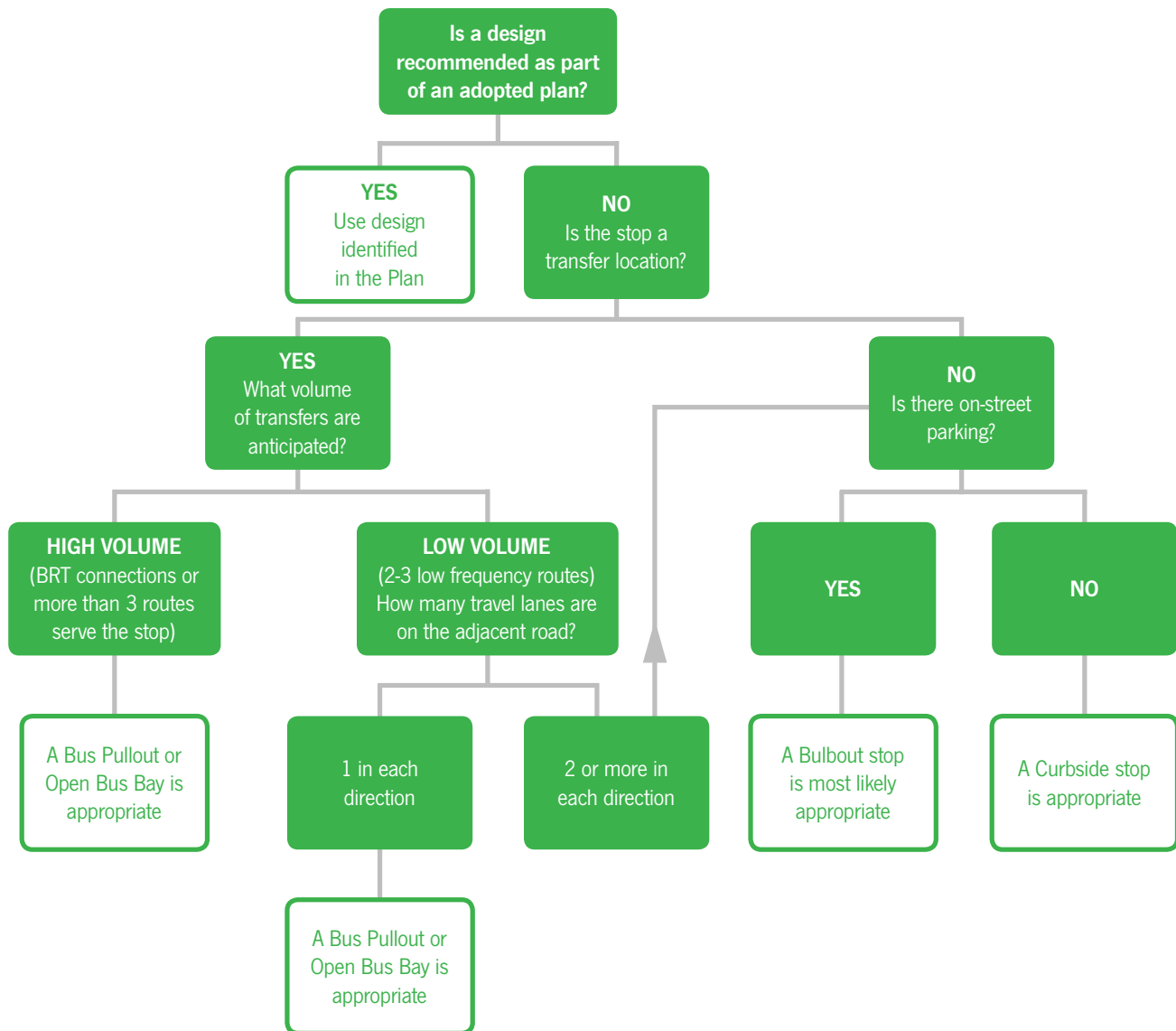


Location (cross streets): \_\_\_\_\_

Block Location:     Near-side                       Far-side                       Mid-block

Service:                       On Existing Transit Route                       Future Transit Route

### Street-Side Design Considerations:





## Curb-side Design Considerations:

|   |  |
|---|--|
| <p><b>Projected Ridership (boardings)</b><br/> <b>Low Ridership</b> (&lt;25 daily boardings) – 0 points<br/> <b>Moderate Ridership</b> (25–50 daily boardings) – 2 points<br/> <b>High Ridership</b> (&gt;50 daily boardings) – 5 points<br/> <b>Very High Ridership</b> (200+ daily boardings) – 10 points</p> |  |
| <p><b>Land Use Density (Zoning)</b><br/> <b>Low Density</b> (RUL, UE, RF, RL, POL or County) – 0 points<br/> <b>Medium Density</b> (NCL, NCB, LMN, RC, RDR, NC, CL, E, I) – 2 points<br/> <b>Higher Density</b> (NCM, MMN, HMN, D, CC, CCN, CCR, CG, CS, HC) – 5 points</p>                                     |  |
| <p><b>Youth, Senior, Disabled or Low-income Population Concentrations</b><br/> (includes schools, dedicated housing, and social service entities)<br/> Within a ¼ mile of population concentrations – 2 points<br/> Within a ⅛ mile of population concentrations – 5 points</p>                                 |  |
| <p><b>Activity Center</b><br/> Within a designated Activity Center or on CSU’s campus – 2 points</p>  |  |
| <p><b>Enhanced Transportation Corridor (ETC)</b><br/> Located along an ETC – 2 points<br/> Designated as Station in an ETC plan – 15 points</p>   |  |
| <p><b>High Exposure to Elements</b><br/> In areas with exposure to wind, rain, high traffic speed, etc. – 5 points</p>  |  |
| <b>TOTAL</b>  |  |

### Scoring

|  | <b>Score Range</b> |
|--|--------------------|
| Type I Stop – Basic accessibility required   | 0 – 1              |
| Type II Stop – Basic accessibility and bench required                              | 2 – 4              |
| Type III   |                    |
| Type III – Basic accessibility, standard shelter, trash and 1 bike rack (2 bikes)  | 5 – 10             |
| Type III – Basic accessibility, standard shelter, trash and 2 bike racks (4 bikes) | 11 – 15            |
| Optional Type IV (upon consideration by transit provider)                          | >15                |

### In-street and Curb-side Design

|   |
|---|
| <p>Recommended In-Street Design:   <input type="checkbox"/> Curb-side Stop   <input type="checkbox"/> Bulbout Stop<br/> <input type="checkbox"/> Bus Pullout Stop   <input type="checkbox"/> Open Bay Stop   <input type="checkbox"/> Queue Jump Stop</p> <p>Recommended Curb-side Stop Type:   <input type="checkbox"/> Type I (Sign Stop)   <input type="checkbox"/> Type II (Bench Stop)<br/> <input type="checkbox"/> Type III (Shelter Stop)   <input type="checkbox"/> Type III (Shelter Stop – 2 bike racks)   <input type="checkbox"/> Type IV (Station Stop)</p> |
|---|

## 6.2 LAND USE CODE SECTION 3.6.5

### 3.6.5 Bus Stop Design Standards (update in progress)

**(A) Purpose.** The purpose of this Section is to ensure that new development adequately accommodates existing and planned transit service by integrating facilities designed and located appropriately for transit into the development plan.

**(B) General Standard.** All development located on an existing or planned transit route shall install a transit stop and other associated facilities on an easement dedicated to the City or within public right-of-way as prescribed by the City of Fort Collins Bus Stop Design Standards and Guidelines in effect at the time of installation, unless the Director of Community Services determines that adequate transit facilities consistent with the Transit Design Standards already exist to serve the needs of the development. All development located on existing transit routes will accommodate the transit facilities by providing the same at the time of construction. All development located on planned routes will accommodate said facilities by including the same in the development plan and escrowing funds in order to enable the city or its agents to construct the transit facilities at the time transit service is provided to the development. All facilities installed shall, upon acceptance by the City, become the property of the City and shall be maintained by the City or its agent.

**(C) Location of Existing and Planned Transit Routes.** For the purposes of application of this standard, the location of existing transit routes shall be defined by the Transfort Route Map in effect at the time the application is approved. The location of planned transit routes shall be defined according to the Transfort Strategic Operating Plan, as amended.

# 6.3 TECHNICAL DESIGNS (As Incorporated into Larimer County Urban Area Street Standards)

**LARIMER COUNTY URBAN AREA STREET STANDARDS**  
**CONSTRUCTION DRAWINGS**  
**DATE: 04/01/07**  
**REVISION NO: 1**  
**DRAWING 711**

**BUS BAY AND STOP STANDARD**

| SPEED LIMIT | LEAD IN LENGTH (L) (FT.) | LEAD OUT LENGTH (Lo) (FT.) |
|-------------|--------------------------|----------------------------|
| <35         | 60                       | 60                         |
| 40          | 100                      | 70                         |
| 45          | 150                      | 80                         |
| 50          | 200                      | 90                         |
| 55          | 250                      | 100                        |

NOTE:  
 1. Length of bus pad varies as directed by the Local Entity.  
 2. All pads shall be a minimum of 10" thick concrete.  
 3. On prepared 6" compacted base.

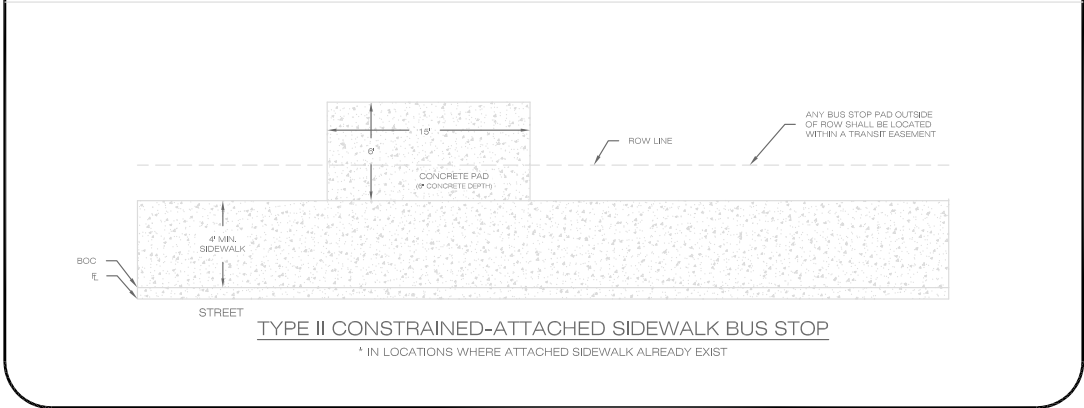
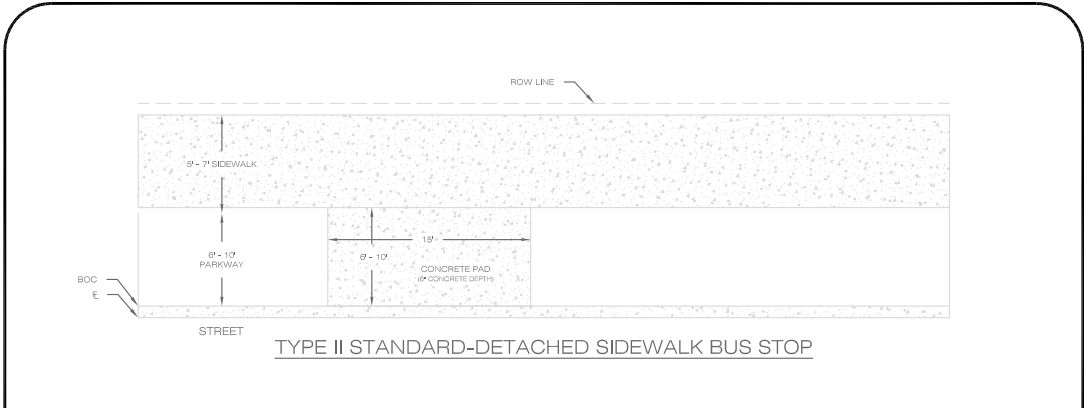
**LARIMER COUNTY URBAN AREA STREET STANDARDS**  
**CONSTRUCTION DRAWINGS**  
**DATE: 04/01/07**  
**REVISION NO: 1**  
**DRAWING 711A**

**BUS BAY AND STOP STANDARD**

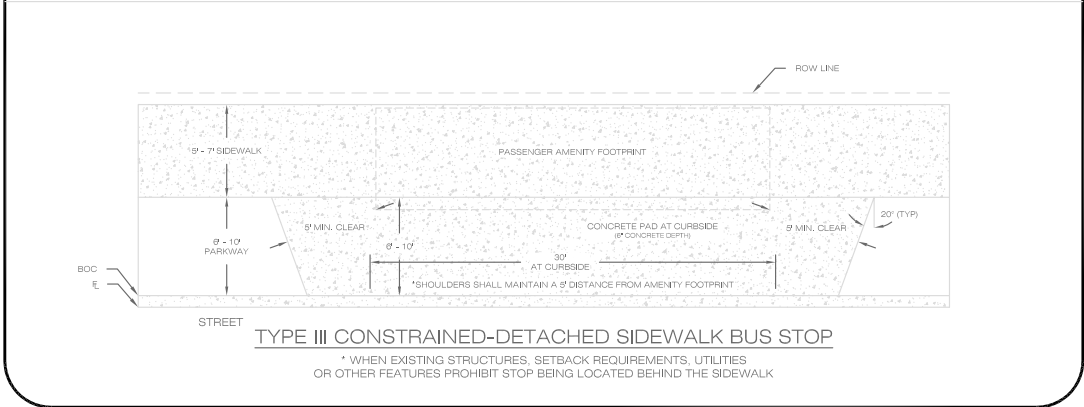
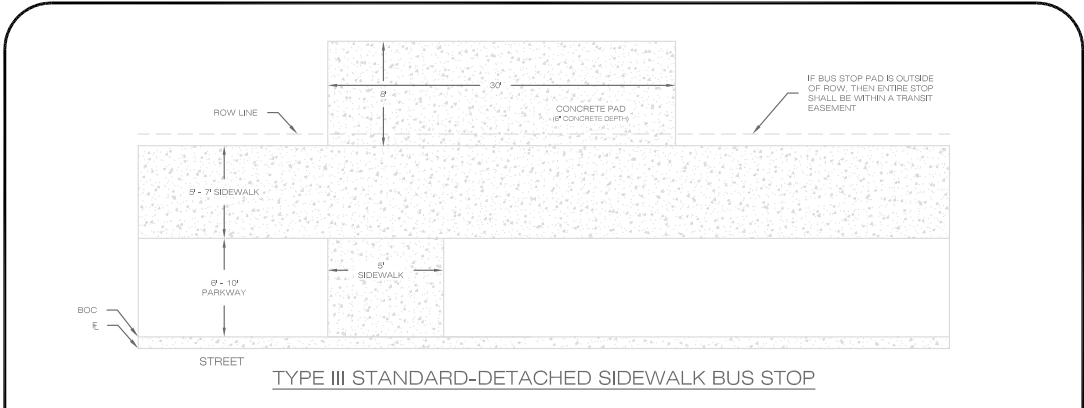
**TYPE I STANDARD-BUS STOP**

**TYPE I CONSTRAINED-BUS STOP**  
 \* IN LOCATIONS WHERE ATTACHED SIDEWALK ALREADY EXIST

|   |  |                          |  |                 |  |                 |  |
|---|--|--------------------------|--|-----------------|--|-----------------|--|
| LARMER COUNTY<br>URBAN AREA<br>STREET STANDARDS |  | CONSTRUCTION<br>DRAWINGS |  | REVISION NO.: 1 |  | DRAWING<br>711B |  |
| <b>BUS BAY AND STOP STANDARD</b>                |  |                          |  | DATE: 04/01/07  |  |                 |  |

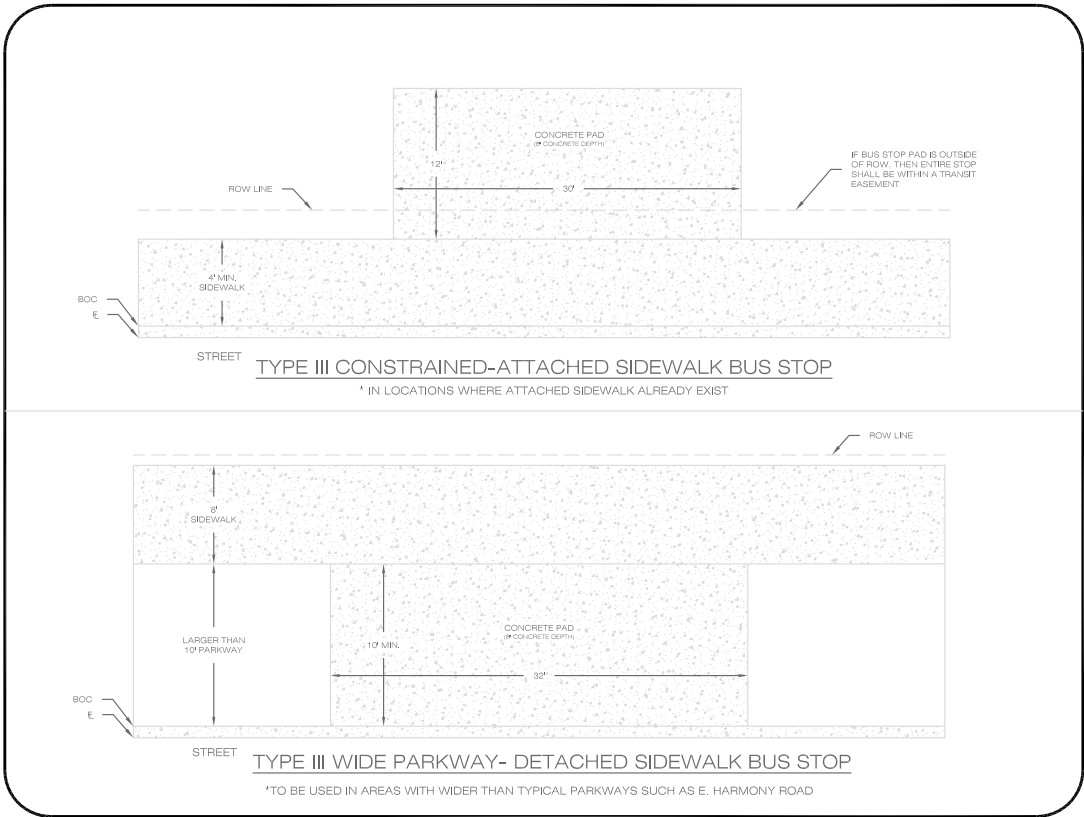


|   |  |                          |  |                 |  |                 |  |
|---|--|--------------------------|--|-----------------|--|-----------------|--|
| LARMER COUNTY<br>URBAN AREA<br>STREET STANDARDS |  | CONSTRUCTION<br>DRAWINGS |  | REVISION NO.: 1 |  | DRAWING<br>711C |  |
| <b>BUS BAY AND STOP STANDARD</b>                |  |                          |  | DATE: 04/01/07  |  |                 |  |





|   |  |                           |                |
|---|--|---------------------------|----------------|
| LARMER COUNTY<br>URBAN AREA<br>STREET STANDARDS |  | BUS BAY AND STOP STANDARD |                |
|   |  | CONSTRUCTION<br>DRAWINGS  | REVISION NO: 1 |
| DATE: 04/01/07                                  |  | DRAWING<br>711D           |                |



# 6.4 CITIZEN ADVISORY COMMITTEE LETTER OF SUPPORT

Date: May 20, 2015

To: Fort Collins Transfort

From: Fort Collins Transit Design Standards Citizen Advisory Committee

Re: Bus Stop Design Standards and Guidelines Draft

To Whom It May Concern,

Following The Transit Design Standards Citizen Advisory Committee meeting on Monday, April 13, 2015 and after much discussion, we wish to convey our support and endorsement of the *Bus Stop Design Standards and Guidelines*. The Guidelines include the following:

### Bus Stop Design Standards and Guidelines Highlights

- **Accessibility Enhancements** - Updates the Accessibility Requirements of bus stops to be in compliance with ADA standards
- **Bus Stop Amenity Distribution** - Enhances bus stop passenger amenity provision throughout the Transfort Service Area
- **Capital Improvement Plan** - Sets a goal of bringing approximately 20 bus stops into compliance with these standards each year
- **Next Steps** – Identifies the next steps to pursue Braille signage at bus stops and recommends further evaluation of how snow removal is enforced throughout the City

The Fort Collins Transit Design Standards Citizen Advisory Committee believes it is appropriate and highly important to include the *Bus Stop Design Standards and Guidelines* in Transfort's plans for all bus stop plans. We are particularly sensitive to ADA requirements therefore, we encourage Transfort to seriously consider and include all such regulations in any bus stop designs. Bus stop accessibility and safety is of serious concern in the growing Fort Collins community and should be guaranteed to all citizens. Bus stops are a key link in the journey of a bus rider. For people with disabilities, inaccessible bus stops often represent the weak link in the system and can effectively prevent the use of fixed-route bus service. Physical, cognitive, and psychological barriers associated with bus stops can severely hamper bus ridership by the disability community, thus limiting their mobility and potentially leading to increased paratransit costs. As such, Transfort is encouraged by this committee to advocate for accessibility improvements and barrier removal in all bus stop designs. Thank you for your consideration of this written endorsement.

Sincerely,

The Fort Collins Transit Design Standards Citizen Advisory Committee Members

Fort Collins, Colorado

05/20/2015

Citizen Advisory Committee Member Signatures:

Sarah Allmon 6-3-15  
Sarah Allmon Date

Noah Al Hadidi 5/26/15  
Noah Al Hadidi Date



Vivian Armendariz 6/19/15  
Vivian Armendariz Date

Michael R Devereaux  
Michael Devereaux Date



Kathryn Grimes 06/01/2015  
Kathryn Grimes Date

Jamie Rideoutt  
Jamie Rideoutt Date

Ed Robert  
Ed Robert Date

Carol Thomas 6-24-15  
Carol Thomas Date